

ROYAL ENFIELD OWNER'S MANUAL



BS IV

FOREWORD

Congratulations. You now own a piece of history!

The Royal Enfield Interceptor is our heritage-inspired machine, built for the modern, intrepid traveller.

With your new machine, we mark the return of one of Royal Enfield's most loved classic motorcycles - the Interceptor.

Harking back to a time when all that mattered was that the Californian sun was out and the surf was up, this motorcycle retains the charm that made it legendary.

Designed to be simple and robust with solid and precise engineering, the Interceptor has been built to be your faithful companion on rides and adventures, big and small. Powered by our brand-new air-cooled 648cc twin cylinder engine and robust twin cradle chassis developed at our state-of-the-art tech centre in the United Kingdom, we hope you enjoy riding your motorcycle as much as we enjoyed building it for you.

This manual is your friend, philosopher, and guide when it comes to taking care of your motorcycle. In the pages that follow, you will find ways of looking after your machine so that it remains a reliable partner in your travels and exploration for decades to come.

Please do avail of all the services at your nearest Authorised Service Centre to make sure that your motorcycle gets the right treatment which it so deserves. Please also read through the terms and conditions of warranty and other useful information in this manual before riding off into the sunshine.

Keep riding pure.

For support and information please call 1800 210 0007 any time between 9 AM and 9 PM, any day of the week.

To know more about Royal Enfield, our products, and other news, go to www.royalenfield.com

NOTICE

All information in this manual is based on the latest product information available at the time of publication. Due to continuous improvements, there may be discrepancies between the information in this manual and your motorcycle.

Royal Enfield reserves the right to make production changes at any time without prior notice and without incurring any obligation to make the same or similar changes to motorcycle previously built or sold.

"© Copyright 2018 Royal Enfield (A unit of Eicher Motors Ltd.). All Rights Reserved. No part of this manual shall be copied, distributed or otherwise dealt without the express permission in writing from Royal Enfield".

All images shown are for reference to explain and need not to be exactly the same on the model you own. Technical specifications are subject to change without prior notice.

Disclaimer

- This model fitted with "tubeless tyre" is provided with an inner tube.
- Failure to use an inner tube in a spoked wheel will cause deflation of the tyre resulting in loss of motorcycle control.
- The approved tyres marked with "TUBELESS" are suitable for use with inner tube.

Contact Us:

Royal Enfield Support : 1800-2100-007

Email : support@royalenfield.com

Twitter : @RoyalEnfieldSupport

Web : www.royalenfield.com

Part No. RAM00098/A / Qty. 500 / Nov. '18

CONTENTS

Safety Definitions.....	5
Personal and Motorcycle Information.....	6
Safe Riding Tips / Guidelines.....	7
Rules of the Road.....	13
Accessories and Luggage.....	16
Technical Specifications.....	18
Recommended Lubricants.....	26
Motorcycle Identification Numbers.....	28
Engine Number Details.....	30
Location of Key Parts.....	31
Operation of Controls.....	34
Warning Indications and Safety Systems.....	45
Pre-Operational Checks.....	50
Running in Period.....	51
Starting.....	53
Gear Shifting, Riding and Stopping.....	57
Parking.....	60

CONTENTS

Tools Kit.....	62
First Aid Kit	63
Minor Maintenance Tips.....	64
Long Trip Precautions.....	101
Washing Procedure.....	103
Storage Precautions.....	105
Trouble Shooting.....	106
Periodical Maintenance Chart.....	114
Warranty Terms and Conditions.....	118
Emission Warranty.....	121
EVAP.....	127
Environment Care.....	128
Service Coupons	131
Service Maintenance Record	133
Regional & Area Offices	135
Authorised Dealer Address	136
Notes.....	176

SAFETY DEFINITIONS

The information given under the titles: Warning, Caution and Note are for your safety and for the care and safety to your motorcycle and others. Please read these carefully and if disregarded may result in injury to yourself or others and damages to the motorcycle.



WARNING

Indicates a potentially hazardous situation. Disregarding this message may result in injury to rider or other persons.

CAUTION

This message, if disregarded, may result in damage to the motorcycle.

NOTE

Indicates important and useful messages for better understanding.

PERSONAL AND MOTORCYCLE INFORMATION

Name		
Door No./Street		
Locality/Town		
City		Country
Contact	Res :	Off :
	Mobile :	Email :
Licence No.	Valid till :	
Model	Color :	
Engine No.		
VIN. No.		
Tyre make	Front :	Rear :
Tyre Nos.	Front :	Rear :
Battery make	Battery No.	
Sold by		
Date of Sale		

SAFE RIDING TIPS / GUIDELINES

- Before operating your new motorcycle, we request you to carefully read and follow the operating and maintenance instructions detailed in this manual for the safety of your own, your motorcycle, and also that of others.
- Know and adhere to the rules of the road with respect to your driving country.
- Before starting the motorcycle, check for proper operation of brakes, clutch, gear shifter, handle bar controls, tyre pressures, fuel and oil levels, etc.
- Use only genuine Royal Enfield spare parts and approved accessories. Use of other manufacturer's parts may affect the performance of your motorcycle and render the motorcycle void of warranty. Visit your Royal Enfield Authorised Service Centre for details.
- Whenever refueling your motorcycle, please exercise utmost caution and carefully observe the following guidelines.
 - ★ Refuel in a well ventilated area with the engine turned off condition.
 - ★ Open the fuel filler cap slowly.
 - ★ Switch OFF mobile phones and other hand held electronic devices.
 - ★ DO NOT smoke and please ensure that there are no open flames or sparks near the motorcycle, when refuelling OR servicing the fuel system.

SAFE RIDING TIPS / GUIDELINES

- ★ DO NOT fill the tank to its brim. Please fill fuel till the bottom of anti splash plate, so as to leave sufficient air space in the fuel tank to allow for fuel expansion.

WARNING

Royal Enfield cautions you against the use of certain nonstandard parts such as aftermarket and custom made extended front forks or suspensions, which may adversely affect performance and handling. Removing or altering original parts may adversely affect performance and could result in accident.

- A new motorcycle must be operated according to the special running-in-procedure. See running-in-procedure mentioned in respective section.
- Operate motorcycle only at moderate speeds and out of traffic until you have become thoroughly familiar with its operation and handling characteristics under all conditions.
- DO NOT exceed the legal speed limit or ride too fast for existing conditions. Always reduce speed when poor riding conditions exist. High speed increases the influence of any other condition affecting stability and increases the possibility of loss of control.

SAFE RIDING TIPS / GUIDELINES

NOTE

If you are an inexperienced rider we recommend that you obtain formal training on correct motorcycle riding techniques and become thoroughly familiar with the operation of your motorcycle. New riders should gain experience under various conditions while driving at moderate speeds.

Pay strict attention to road surfaces and wind conditions. Any motorcycle may be subject to the following upsetting forces:

- ★ Wind blasts from passing vehicles.
- ★ Rough or uneven road surfaces.
- ★ Slippery road surfaces.

These forces may affect the handling characteristics of your motorcycle. If this happens, reduce speed of the motorcycle to a controlled condition. Do not apply brake abruptly.

- Operate your motorcycle defensively. Remember that a motorcycle does not afford the same protection as an automobile in an accident. One of the most common accident situations occurs when the rider / driver of the other motorcycle / vehicle fails to see or recognise a motorcycle and turns into the oncoming motorcyclist.

SAFE RIDING TIPS / GUIDELINES

- Wear an approved helmet, clothing, and footwear suited for riding a motorcycle. Bright/light colours are best for greater visibility in traffic, especially at night. Avoid loose, flowing garments and scarves.
- When carrying a pillion rider, it is your responsibility to instruct them on proper riding procedures.
- DO NOT allow other individuals, under any circumstances, to operate your motorcycle unless you know they are experienced, licensed riders and are thoroughly familiar with the operating conditions of your motorcycle.

WARNING

Regularly inspect shock absorbers and front forks and look for leaks. Replace worn out parts. Worn out parts can adversely affect stability and handling.

WARNING

For your personal welfare, all the listed service and maintenance recommendations should be performed. Lack of regular maintenance at the suggested intervals may affect the safe/durability/longevity operation of your motorcycle.

SAFE RIDING TIPS / GUIDELINES

 **WARNING**

Avoid any contact with the exhaust system when hot. Wear clothing that will completely cover the legs while riding. The exhaust system gets very hot when the engine is running and remains too hot to touch, even after the engine is turned off. Failure to wear proper or protective clothing could result in serious injury.

 **WARNING**

Exhaust gas contains poisonous carbon monoxide and chemicals, known to cause cancer, birth defects or other reproductive defects.

 **WARNING**

Motorcycle batteries contain lead, acids and chemicals known to cause cancer, birth defects or other reproductive harm. Exercise extreme caution while handling a battery, wash hands thoroughly whenever a battery is handled.

SAFE RIDING TIPS / GUIDELINES

WARNING

Consult your Royal Enfield Authorised Service Centre regarding any questions or problems that occur in the operation of your motorcycle. Failure to do so may aggravate an initial problem, cause costly repairs and jeopardize your personal safety.

WARNING

DO NOT tow a motorcycle. The steering and handling of the towed motorcycle will be impaired due to the force of the towline. If a motorcycle must be transported, use a truck or a trailer.

WARNING

DO NOT pull a trailer behind a motorcycle. Towing a trailer may cause reduced braking efficiency, tyre overloading and unstable handling, as it may cause loss of control of the motorcycle in the front, leading to an accident.

RULES OF THE ROAD

- Be sure your number plate is installed in the position specified by law and it is clearly visible at all times.
- Ride at a safe speed that is consistent with the type of road surface you are on. Pay strict attention while riding on the following surfaces :
 - ★ Dusty
 - ★ Oily
 - ★ Icy
 - ★ Wet
 - ★ Sand
- Watch for loose debris, such as leaves, slippery substances or gravel that can hamper the stability of your motorcycle.
- Keep to the correct side of the road centre line when meeting oncoming vehicles.

RULES OF THE ROAD

- Actuate your turn signals and exercise caution when passing other vehicles going in the same direction. Never try to pass another vehicle going in the same direction at street intersections, on curves, or when going up/or down a hill.
- At street intersection give the right-of-way to the motorcycle on your left or right. DO NOT presume you have the right-of-way.
- Adhere to the rules of the road with respect to your country when preparing to stop, turn or pass. While turning either right or left, watch for pedestrians, animals, as well as other vehicles.
- All traffic signs, including manual controls at intersections, should be obeyed promptly. SLOW DOWN at traffic signs near schools and CAUTION signs at railroad crossings.
- When intending to turn, signal at least 100 feet (30.5 meters) before reaching the turning. Be close to the centre line (unless local rules require otherwise), slow down and then turn carefully.
- Never jump a traffic light. When a change is imminent from GO to STOP (or vice versa) at intersections, slow down and wait for the light to change to green. Never run through a yellow or red traffic light.
- DO NOT leave the curb or parking area without signalling. Be sure your way is clear to enter moving traffic. A moving line of traffic always has the right-of-way.

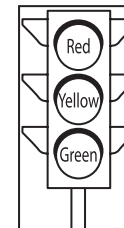

RULES OF THE ROAD

- When parking the motorcycle, park on a firm and flat surface to prevent it from falling over.
- Protect your motorcycle against theft. After parking your motorcycle, ensure that the steering head is locked and then remove the ignition key.

SIDE VIEW MIRRORS

Your motorcycle is equipped with convex mirrors and have a curved surface. This type of mirror is designed to give a much wider view of the rear than a normal flat mirror. However, vehicles and other objects seen in this type of mirror will look smaller and farther away than when seen in a flat mirror.

Use care when judging the size or distance of vehicles / objects seen in these mirrors.

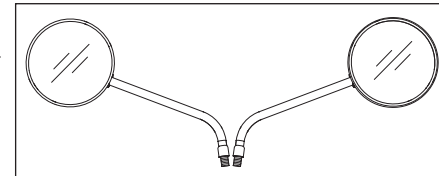

NOTE

To establish the relative distance of vehicles / objects behind your motorcycle through the mirrors, adjust each mirror in such a way, that a small portion of your shoulder is visible and a large portion behind your motorcycle is seen clearly with reference to your riding posture.

ACCESSORIES AND LUGGAGE

Royal Enfield offers a range of Genuine Motorcycle Accessories that have been fully approved and extensively tested alongside the motorcycle.

Therefore, the rider must be responsible for safe operation of the motorcycle when installing accessories or carrying additional weight. (Max. pay load: 200 kg)

Please adhere to the following guidelines when carrying a pillion, luggage or when fitting any accessories.

- DO NOT exceed 110km/h / 70 mph when riding solo, carrying a pillion or payload on an accessory equipped motorcycle.
- Keep luggage weight concentrated close to the motorcycle and as low as possible; this minimizes sudden shift in the motorcycle's centre of gravity.
- Distribute weight evenly on both sides of the motorcycle.
- DO NOT load bulky items behind the rider or add weight to the handlebars or front forks.
- DO NOT exceed 6.6 pounds (3 kgs) maximum weight in each Royal Enfield Genuine motorcycle accessory pannier.
- Re-check the luggage periodically to ensure it is secured and will not shift while riding. Accessories mounted loosely may affect the riding of the motorcycle and affect the handling and stability of the motorcycle.
- Large surfaces such as fairings, windshields, backrests and luggage racks can adversely affect handling of the motorcycle. Use Royal Enfield Genuine Motorcycle Accessories which are model specific and follow installation procedure.

ACCESSORIES AND LUGGAGE

 **WARNING**

DO NOT load weight or install accessories incorrectly on the motorcycle. Doing so may affect the motorcycle's stability, handling characteristics and safe operation and could result in an accident causing serious injury or loss of life.

 **WARNING**

Royal Enfield offers a range of Genuine Motorcycle Accessories that have been fully approved and extensively tested alongside the motorcycle.

 **WARNING**

Royal Enfield cautions you against use of nonstandard parts such as aftermarket and custom made extended front forks which may adversely affect the performance and handling of the motorcycle. Removing or altering original parts may adversely affect the performance of the motorcycle, causing an accident, which could result in serious injury or loss of life.

 **WARNING**

DO NOT ignore model / design specifications. Doing so constitutes both motorcycle and accessories misuse which may adversely affect the handling and performance of the motorcycle causing an accident, which could result in serious injury or loss of life.

TECHNICAL SPECIFICATIONS

ENGINE

Engine Type	Inline Twin Cylinder, 4 Stroke, SOHC
Bore	78mm
Stroke	67.8mm
Swept volume	648cc
Compression ratio	9.5:1
Max Power	34.9 kw (47.4 PS) @ 7150 rpm
Max Torque	52.3 Nm @ 5150 rpm
Idle RPM	1200±80 RPM
Starting	E-Start
Air filter element	Paper element
Lubrication	Forced lubrication, Wet sump with pump driven oil delivery
Gear Box	6 Speed Constant Mesh

TECHNICAL SPECIFICATIONS

Engine oil capacity	Dry Fill	3.9 litre
	Refill	3.1 litre
Engine oil grade	Fully synthetic 10W-50 to API SL (or higher) or JASO MA2, such as ELF MOTO4 TECH 10W 50	
Fuel Supply	Fuel Injection	
Cooling	Air cooling	

IGNITION SYSTEM

Ignition	Digital Spark ignition	
Ignition Advanced	11.25° BTDC	
Spark Plug	BOSCH UR5CC	
Spark Plug Gap	0.7 to 0.8 mm	

TECHNICAL SPECIFICATIONS

TRANSMISSION

Clutch	Wet multiplate
Primary drive	Gear
Primary ratio	2.051 : 1
Gear box	6 Speed Constant Mesh
Gear Ratio	1 st 2.615:1
	2 nd 1.813:1
	3 rd 1.429:1
	4 th 1.190:1
	5 th 1:040:1
	6 th 0:962:1
Secondary drive	Sprockets and Chain (5/8" Pitch)
Secondary Ratio.....	2.533:1

TECHNICAL SPECIFICATIONS

CHASSIS

Frame	Steel Tubular, Double Cradle Frame
Suspension	
Front	41 mm Front Fork, 110 mm travel
Rear	Single Coil-over Shocks, 88 mm travel
Hydraulic Disc Brakes	Front and Rear with ABS system.
	Front: 320 mm disc, ABS
	Rear: 240 mm disc, ABS
	ABS: BOSCH 9.1
	Brakes: Dual Channel ABS
Brake Fluid:	Grade: DOT 4
Tyre size:	Capacity: Front: 50 ml Rear: 100 ml
Front	100/90-18 M/C 56H, Pirelli Phantom Sports Comp
Rear	130/70-18 M/C 63H, Pirelli Phantom Sports Comp

NOTE

The Imported Pirelli Tyres which are fitted in this motorcycle meet the requirements of BIS and that they comply with the requirements under the Central Motor Vehicles Rules (CMVR), 1989, would suffice;

TECHNICAL SPECIFICATIONS

Tyre Pressure:

Solo

Front..... 32 psi/2.20 kg/cm²

Rear..... 36 psi/2.53 kg/cm²

With Pillion

Front..... 32 psi/2.20 kg/cm²

Rear..... 39 psi/2.74 kg/cm²

Steering Lock..... Combination Lock

Fuel Type Unleaded Gasoline

Ethanol content E10 or less

Minimum Octane Rating 91 RON (Research Octane Number) or Higher

Induction Fuel Injected

Fuel tank capacity 13.7* litre

Low Fuel Warning 2.9* litre

Dead Stock 0.75* litre

* The above values are approximate and the actual fuel filling capacity will vary from the values mentioned.

TECHNICAL SPECIFICATIONS

ELECTRICALS

System	12V - DC
Generation	Alternator
Alternator Output	156 W @ 1100 rpm
Battery	12V - 12 Ah VRLA
Head lamp	12V, H4 60/55W
Brake/Tail lamp	12V, P21/5W (Halogen)
Turn signal	12V, R10W
Instrument Cluster	Digital Instrument Cluster with LCD
Horn	320 Hz Low and 420 Hz High Tone
Starter Motor	12V, 0.8 KW



WARNING

Using bulbs / other electrical accessories other than specified rating may lead to over loading / erratic behaviour / premature failure of electrical system. Modifications on the motorcycle which are not approved by Royal Enfield may not only disqualify for warranty, but will also affects the performance of the motorcycle.

TECHNICAL SPECIFICATIONS

DIMENSIONS

Rake	24 degrees
Front Wheel	18 M/C x MT 2.50
Rear Wheel	18 M/C x MT 3.50
Length.....	2119 mm
Width	857 mm (with mirrors)
Height	1120 mm
Wheel base	1398 mm
Ground Clearance	174 mm

TECHNICAL SPECIFICATIONS

WEIGHTS

Kerb weight (90% Fuel and Oil)	213 kg
Max. pay load	200 kg (Inclusive of rider mass)

NOTE

- Values / dimensions given above only for your guidance.
- In view of continuous improvements being done on our products, the specifications could change without prior notice.

RECOMMENDED LUBRICANTS

Engine Oil			Front Fork Oil		Brake Fluid	
Grade	Fully synthetic 10W-50 to API SL (or higher) or JASO MA2, such as ELF MOTO4 TECH 10W 50		Grade	2W 25 HPCL	Grade	DOT 4
Capacity	1st Dry Fill : 3.9 litre	Routine Oil Change : 3.1 litre	Capacity	473 ml / Fork	Capacity	Front: 50 ml Rear: 100 ml
			* DO NOT Mix DOT 4 or other brake fluids together.		Brake System	
					Dual Channel ABS	

CAUTION

Use of wrong oil grade will reduce the life of the moving parts and seriously affect performance.

NOTE

Recommendation subject to change without notice.

ISO 14001 OPERATION CONTROL PROCESS

As per the guidelines in ISO 14001 Environmental Management System, customers are advised to carry out timely replacement of engine oil, fork oil and brake fluid, ONLY through a Royal Enfield Authorised Service Centre for the safe disposal of the used oils to prevent environmental pollution.

In case the oils are replaced privately, it is advised to ensure the old / removed oils are collected carefully and disposed through a certified disposal agency.

Similarly, hazardous waste such as old / discarded batteries, tyres, tubes, cables, gaskets, oil filters etc. should also be disposed off carefully and properly, through a certified disposal agency.

MOTORCYCLE IDENTIFICATION NUMBERS

The VIN is a 17 digit number punched on the right side steering head tube in the form of label.

Sample VIN :	ME3	X X	XX	X	X	J	X	XXXXXX
Manufacturer's code								
Type of Frame								
Type of Engine								
Commercial Name								
Ignition System								
Transmission Type								
Production Year (2017:H, 2018:J, 2019:K)								
Manufacturing Plant (0-Thiruvottiyur, 1-Oragadam, 2-Vallam)								
Production Serial No.								

MOTORCYCLE IDENTIFICATION NUMBER

CHASSIS NUMBER

Punched on the steering head tube right side.

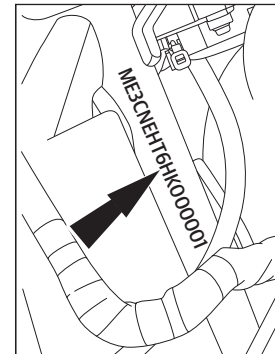

CAUTION

It is illegal to tamper with the VIN information label as it is the only means of identifications of the motorcycle.

ENGINE NUMBER - DETAILS

The engine number is punched above the oil filter location. It is the means of identification of the engine serial number and its production details. It is illegal to tamper with the engine number as it is the only means of identifications of the engine.

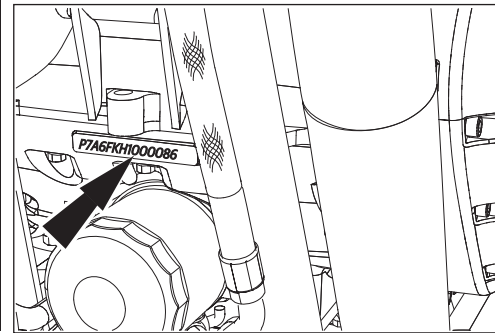
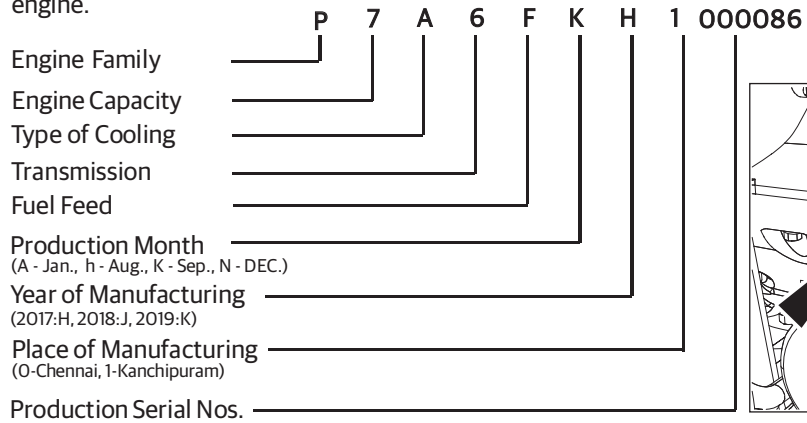

LOCATION OF KEY PARTS

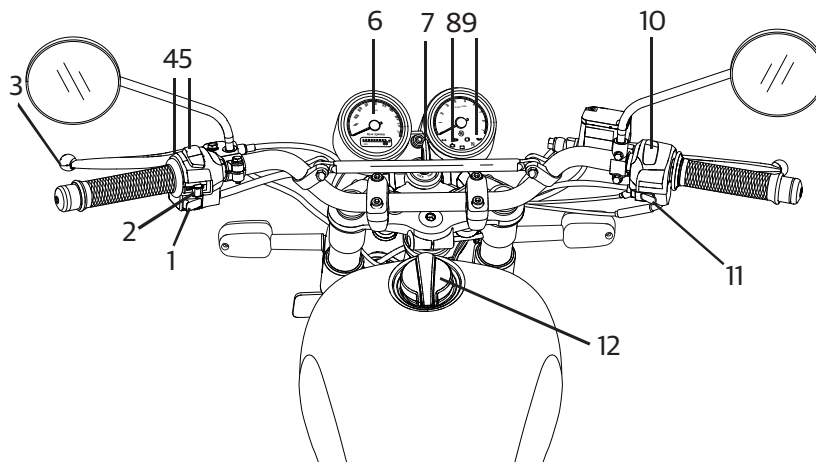

1. Horn Button
2. Turn Signal Switch
3. Clutch Lever
4. Day Flash Switch
5. High Beam / Low Beam Switch
6. Instrument Cluster
7. Ignition Switch
8. Malfunction Indicator Lamp
9. RPM (Tacho) Meter
10. Engine Kill switch
11. Electric Start Switch
12. Fuel Tank Cap

LOCATION OF KEY PARTS

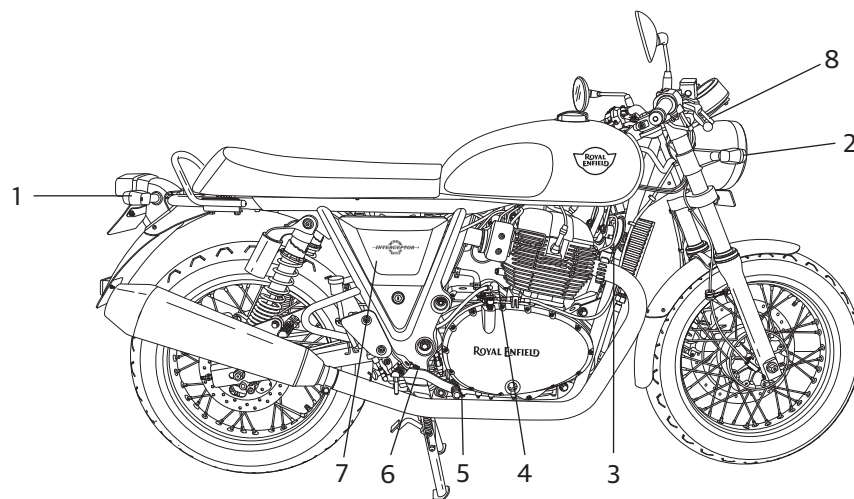

1. Right Trafficator Rear
2. Right Trafficator Front
3. Horn
4. Starter Motor
5. Brake Pedal
6. Brake Lever Rear
7. Right Side Panel
8. Brake Lever Front

LOCATION OF KEY PARTS

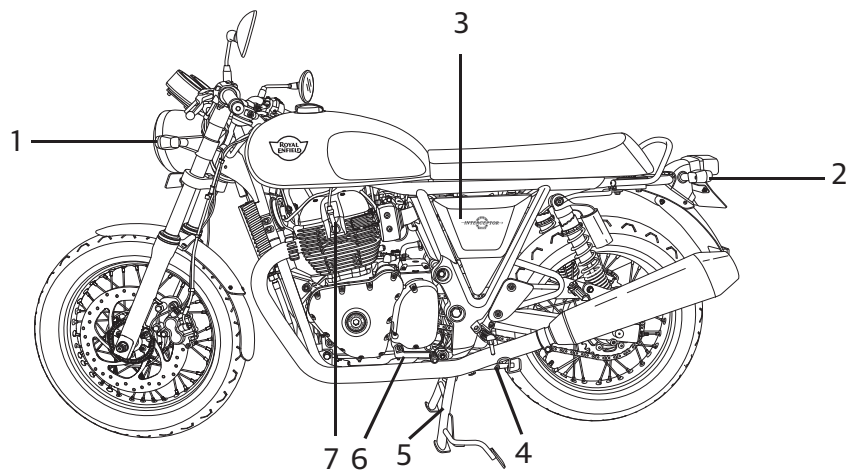

1. Left Trafficator Front
2. Left Trafficator Rear
3. Left Side Panel
4. Side Stand
5. Centre stand
6. Gear Change Pedal
7. Spark plug

OPERATION OF CONTROLS

IGNITION SWITCH

- OFF: Steering unlock, ignition "OFF"
- ON: Steering unlock, ignition "ON"

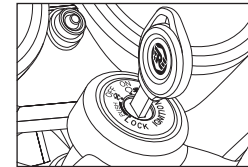

NOTE

- Key is common for ignition, petrol tank lock, steering lock and side panels.
- Key can be removed from fuel tank, side panel only in locked position from the key slots.

STEERING LOCK

- Turn the handle bar to extreme left or right position.
- Push the key inside at "OFF" position, press and further turn to anticlockwise direction to lock the steering and remove the key.
- To unlock, insert the key in steering at lock position, and turn clockwise direction.



OPERATION OF CONTROLS

FUEL TANK CAP

- Lift key flap on fuel tank cap and insert key.
- Turn key clockwise to open.
- Press cap to lock with key in position.
- Remove key from cap and close flap

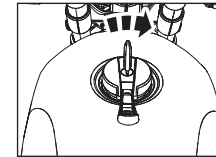

WARNING

- DO NOT overfill the fuel tank.
- Fill fuel only till the bottom of anti splash plate.
- Over filling may result in gasoline entering the EVAP canister and may damage the Evaporative Emission System.

CAUTION

Gasoline vapour is highly explosive. Please ensure there are no open flames or sparks nearby while refueling and fill fuel only in a well ventilated area.

Please ensure gasoline does not spill on painted surfaces. In case fuel spills over the painted surfaces wipe it off immediately as it may leave a permanent stain.

Do not smoke while refueling or when fuel tank cap is open.

OPERATION OF CONTROLS

FUEL FILLING LEVEL

1. Fuel filler collar
2. Anti splash plate
3. Maximum fuel level

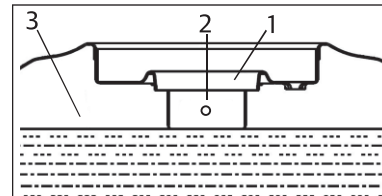

ENGINE KILL SWITCH

-  Engine "OFF"  Engine "ON"

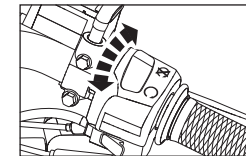

CAUTION

- Turn off ignition switch when engine is not running. Failure to do so will discharge the battery due to the headlamp being continuously "ON".

OPERATION OF CONTROLS

E-START SWITCH

-  Depress and hold until engine starts for a maximum of 5 seconds.

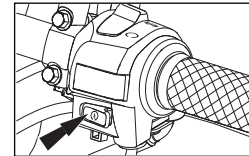

HORN

-  Press the horn button to sound horn.

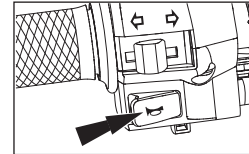

HI BEAM / LOW BEAM SWITCH

- When the headlamp is in ON condition “High / Low beam” will be selected by toggling the switch. High beam indicator lamp located in instrument cluster will glow when high beam is selected.

 High beam  Low beam

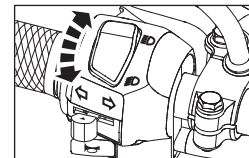

OPERATION OF CONTROLS

DAY FLASH

Press the switch for Day flash.

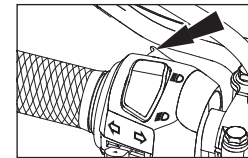

TURN SIGNAL SWITCH

- ← Left turn signal "ON"
- Right turn signal "ON"
- ↑ "OFF" (Push to cancel)

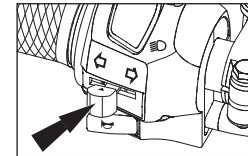

Push the button from "OFF" position to either left or right before turning as needed and restore to "OFF" position to stop blinking.

OPERATION OF CONTROLS

SIDE PANEL LEFT

- To access the left side panel remove the seat and retaining screw, pull and disengage the side panel from locater and gently remove the side panel.



SIDE PANEL RIGHT

- Turn key clockwise to unlock the side panel.
- Pull the side panel along with key to gently remove the side panel.

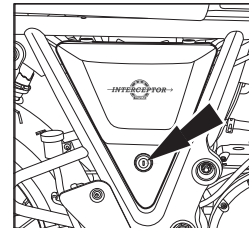

OPERATION OF CONTROLS

INSTRUMENT CLUSTER

This instrument cluster consists of the following:

1. Speedometer
2. Odometer
3. Selection Button
4. Trip Meter 'A' and 'B'
5. Turn Signal Indicator
6. Hi beam Indicator
7. Engine Malfunction Indicator
8. Battery Low Voltage Indicator
9. Fuel Level Indicator
10. ABS Indicator

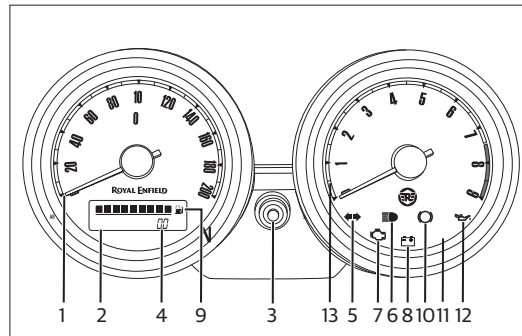

11. Neutral Indicator
12. Low Oil Pressure Indicator
13. Tachometer

OPERATION OF CONTROLS

1. SPEEDOMETER

The Speedometer indicates the speed at which motorcycle is travelling and has both kms/miles calibration.

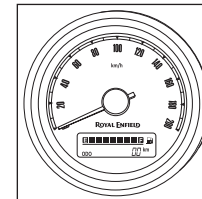

2. ODOMETER

The default display in the odometer is the total kms/miles, the motorcycle has covered



NOTE

The last selection mode will be displayed whenever ignition is switched "ON".

WARNING

It is illegal to tamper with the odometer display or reset the total kms/miles, the motorcycle has covered.
It is illegal to ride the motorcycle after disconnecting the speed sensor of the motorcycle.

OPERATION OF CONTROLS

3. SELECTOR BUTTON

The selector knob will help to select between odometer, Trip 'A' or Trip 'B'.

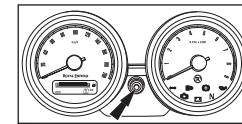

4. TRIP METER A AND B

A light push for less than one second on the select button switch will change the display from odometer Trip 'A'. Again another press on the select button switch will change the display from Trip 'A' to Trip 'B'.

NOTE

1. Set the display as Trip 'A' or Trip 'B' as current mode.
2. Press the select button for more than 3 seconds.
3. Automatically the display will become zero.



WARNING

Do not attempt to change any setting while riding the motorcycle. It may cause loss of control leading to an accident.

OPERATION OF CONTROLS

5. TURN SIGNAL INDICATOR

Indicates that either the left or right indicators are "ON".

6. HI BEAM INDICATOR

Indicates that the high beam head lamp is "ON".

7. ENGINE MALFUNCTION INDICATOR LAMP

A Malfunctioning indicator lamp (MIL) is provided in the tachometer.

When both the ignition and engine kill switch is in "ON" position and after vehicle is started, the MIL will glow for few seconds and switch "OFF" this indicates that all the functions of Electronic fuel injection (EFI) system is functioning normally. In the event of any malfunction in the EFI system MIL will glow continuously. It is recommended to take the motorcycle to a nearest Royal Enfield Authorised Service Centre for a detailed inspection and correction of EFI system.

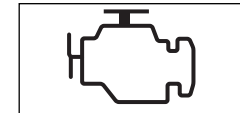
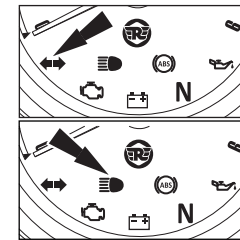

OPERATION OF CONTROLS

8. BATTERY LOW VOLTAGE INDICATOR

When the ignition switch is turned in "ON" position, low voltage indicator symbol will glow. As soon as the engine is started the battery low voltage indicator turns "OFF" automatically.

In case the battery voltage is below 12 volt and the battery is not charging when the engine is started, the battery low voltage indicator will continue to glow in the instrument cluster.

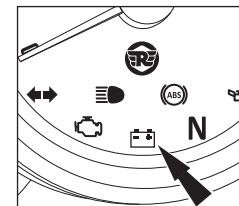

CAUTION

DO NOT ride the motorcycle if the battery low voltage indicator is glowing continuously and please get the charging system checked through an Royal Enfield Authorised Service Centre immediately.

WARNING INDICATIONS AND SAFETY SYSTEMS

Your motorcycle is fitted with the following warning indications and safety systems:

9. FUEL LEVEL INDICATOR

The fuel level indicator indicates the level of fuel in the fuel tank.

The display bars of the fuel meter fades towards the empty (E) when the fuel level decreases from full tank level (F).

The last bar of the fuel level indication in the instrument cluster will blink continuously when the fuel is less than 3 litre (0.8 imperial gallon).

Please do not ride the motorcycle with the low fuel indication blinking continuously as it may not only result in the motorcycle running out of fuel, but will also cause serious damage to the fuel pump. Please refuel as soon as the low fuel indication starts blinking.



WARNING INDICATIONS AND SAFETY SYSTEMS

10. ANTI-LOCK BRAKING SYSTEM (ABS)

Anti-Lock Braking System (ABS) will help prevent the brakes from locking the wheels, during sudden application of the brakes at high speeds or at low friction surfaces. This will help the rider to have better traction and control over the motorcycle and prevent the motorcycle from skidding which can cause an accident.

In the event of a sudden and hard application of the brakes by the rider, the sensors in the braking system will signal the ABS modulator to momentarily and continuously reduce the hydraulic pressure and thereby prevent the brakes from locking the wheels while reducing the speed of the vehicle. This will help the rider to control the motorcycle.

An ABS indicator lamp is provided in the cluster (as shown in the adjacent image) to warn the rider in the event of any malfunction of the ABS.

When the ignition and engine kill switch are switched in "ON" position the ABS sign will glow and remain "ON" till the motorcycle attains a speed of 5 kmph / 3 Mph and turns "OFF". This indicates the ABS is functioning properly. If the ABS indicator lamp does not switch "OFF" and remains continuously "ON" at higher speeds, it is recommended not to drive the ABS motorcycle. Get the brake system inspected and corrected through a nearest Authorised Royal Enfield Service Centre. Failure to do so can result in a serious injuries and loss of life.

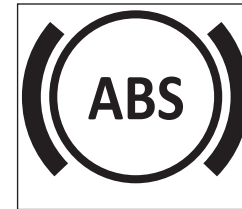

WARNING INDICATIONS AND SAFETY SYSTEMS

CAUTION (ABS)

ABS is a safety feature to help prevent locking of wheels during panic application of brakes. It is by no means a substitute for good riding practices and anticipatory braking.

Please ride carefully and apply brakes cautiously, especially while cornering. ABS cannot estimate the "weight shifts" and momentum of the motorcycle while negotiating a corner and therefore prevent skidding due to loss of traction.

Please anticipate the stopping distance required for the speed of travel and apply brakes well in advance so as to bring the motorcycle to a safe stop.

Please apply both brakes simultaneously to stop with better traction and control of the motorcycle.

Failure to adhere to the above can cause an accident resulting in serious injuries and loss of life.

WARNING INDICATIONS AND SAFETY SYSTEMS

DO'S AND DON'T'S : (ABS)

DO'S	DON'TS
<ul style="list-style-type: none">■ While starting the engine do check the ABS indicator glows "ON" and turns OFF when the vehicle speed exceeds 5 km/h (3.1 mph).■ Please check the brake fluid at "MAX" level in the front and rear brake reservoir and ensure there is no leak in the brake systems.■ Apply both the brakes simultaneously for better efficiency.■ In the event of the ABS indicator remaining continuously "ON", please take the motorcycle to a nearest Authorised Royal Enfield Service Centre to inspect the brake system.	<ul style="list-style-type: none">■ DO NOT RELEASE the brake lever/pedal when pulsations are felt during hard application of the brakes in an emergency situation. The pulsations only indicate that the ABS is activated.■ DO NOT APPLY only the front OR rear brake as it can lead to inefficient braking.

11. NEUTRAL INDICATOR

This indicator glows when the vehicle is in neutral position.

12. LOW OIL PRESSURE INDICATOR

This indicator glows whenever the oil pressure is too low. When the ignition switch is in "ON" position with the engine not running condition the indicator goes off when the engine oil pressure is high enough / normal condition.

WARNING INDICATIONS AND SAFETY SYSTEMS

CAUTION

When the indicator glows continuously and if the engine speed is above idle, stop the vehicle immediately and get the engine inspected and corrected through a nearest Authorised Royal Enfield Service Centre. Failure to do so can cause engine damage.

13. TACHOMETER

This indicates the engine speed in RPM.

ROLL OVER SENSOR

In the event of motorcycle falling over on either of its sides with the engine running and the gear engaged the roll over sensor will disable both the ignition and fuel systems and switch "OFF" the engine. This is to prevent further damage to the motorcycle and the rider.

To reset the roll over sensor and reactivate the ignition and fuel systems.

- Ensure the motorcycle is parked upright on a firm surface.
- Ensure gear is in neutral position and the neutral lamp is glowing in the instrument cluster.
- Turn "OFF" ignition and switch "OFF" engine kill switch, wait for a few seconds and turn "ON" the Ignition and switch "ON" engine kill switch once again, to start the engine.

PRE OPERATIONAL CHECKS

A careful check on the following aspects must be carried out every time before riding and especially after long periods of storage to determine if any additional maintenance is necessary.

1. Adequate fuel in the tank for the journey planned.
2. Tyres for correct pressure, abrasions or cuts.
3. Ensure chain for proper tension and sufficient lubrication.
4. Brakes, clutch, steering and throttle for proper responsiveness.
5. Handle bar controls for smooth operation.
6. Engine oil level.
7. Wheel spokes for proper tightness and damage.
8. Headlamp, tail lamp, brake lamp and indicator lamps for proper functioning.
9. Proper functioning of all the warning lamps in the instrument cluster.



WARNING

For your personal welfare and safety, all the points mentioned above should be performed periodically. Failure to do so may affect safe operation, damage your motorcycle and could result in an accident causing serious injury or loss of life.

RUNNING IN PERIOD

The Royal Enfield Motorcycle as you would be experiencing is capable of consistent high speeds. However as with any new motorcycle, a "RUNNING-IN" procedure is essential to help in proper "Bedding-In" of the various moving parts in your motorcycle and to achieve optimum performance subsequently.

1. DO NOT exceed maximum specified pay load.
2. Warm up the engine for a few minutes at idling speed to allow engine oil to lubricate all the moving parts in the engine before riding the motorcycle.
3. Avoid full throttle operation and do not ride at constant throttle continuously. Vary the speed by 10% while riding.
4. It is recommended to use half clutch condition when commuting in the city traffic condition alone (Engine RPM around idling to 2000 RPM) at 1st gear condition. In Other gears and higher RPM avoid using half clutch which will proportionately reduce the clutch life. During acceleration/ deceleration disengage the clutch completely, shift the gear and engage the clutch gradually (Not too slowly).
5. Ride at proper speed and avoid sudden accelerations and braking.
6. Avoid riding motorcycle continuously for over an hour, it is recommended to take brief stop.

RUNNING IN PERIOD

During the first 2000 Kms of run, do not exceed the speed limits as shown in the table below.

Gear \ Motorcycle Speed	First 500 kms	501 - 2000 kms
1	15 kmph	20 kmph
2	25 kmph	30 kmph
3	30 kmph	40 kmph
4	45 kmph	55 kmph
5	60 kmph	70 kmph
6	75 kmph	85 kmph

NOTE

The below table indicates the recommended engine speed in rpm for optimum performance of the engine.

Distance Covered	Max. Engine Speed
0 to 800 kms (0 to 500 miles)	4000 rpm
800 to 1600 kms (500 to 1000 miles)	6000 rpm

STARTING

- To shift into neutral, move the motorcycle back and forth gently, while simultaneously shifting the gear. Ensure gear is in neutral position and the neutral lamp is glowing in the instrument cluster.

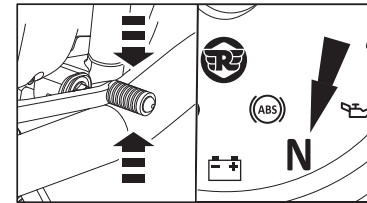

- Turn ignition key to "ON" position and engine kill switch on right hand side handle bar to "RUN" position.

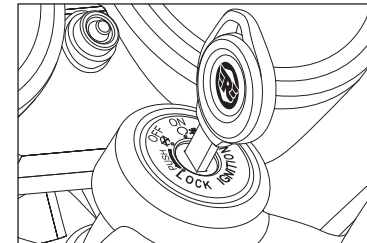

STARTING

- When both the ignition and engine kill switch is in "ON"  position and after the vehicle is started, the MIL will glow for a few seconds and turns "OFF", this indicates that all the function of the electronic fuel injection (EFI) system is functioning normally. In the event of any malfunction in the EFI system the MIL will glow continuously.

CAUTION

- In case the malfunction indicator DOES NOT turn "OFF", get the motorcycle checked through an Royal Enfield Authorised Service Centre for rectification.
- Check the fuel level indicator in the cluster for adequate fuel in the fuel tank. In case the last bar is blinking continuously, it indicates low fuel level in the tank. Please re-fuel immediately.

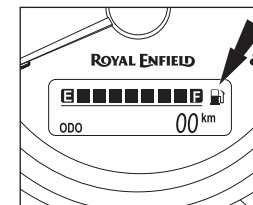
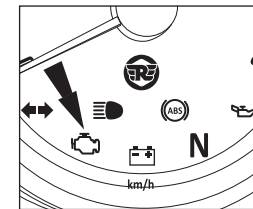

STARTING

- Disengage clutch by pulling in the clutch lever and hold it in depressed condition.
- Depress and hold electric start switch until engine starts for a maximum of 5 seconds.

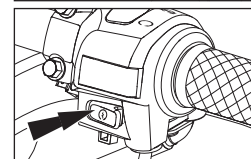
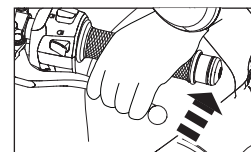

NOTE

In case the engine does not start within 5 second, release starter switch and wait for about 5 second before attempting to start the engine again.

STARTING

CAUTION

If the engine does not start. DO NOT hold the starter switch in depressed condition for long periods, this will cause the battery to drain below the threshold level of 10 volt. Please get the motorcycle checked through an Royal Enfield Authorised Service Centre to identify and correct the reason for not starting.

CAUTION

NEVER accelerate as soon as the engine starts, especially in cold condition. The engine should be allowed to run in idle RPM for at least 2 minute for the engine oil to circulate and lubricate all the internal moving parts and for the engine temperature to raise. Failure to adhere to this important information will cause serious damage to the engine internals.

Accelerate only after the idling RPM has stabilised and it is consistent.

- Ensure side stand is in fully retracted position. Failure to do so will cause the engine to switch "OFF" as soon as gear is engaged.



WARNING

Please exercise extreme care while riding the motorcycle. Failure to do so can result in an accident causing injury to you or to other road users / passerby.

GEAR SHIFTING, RIDING AND STOPPING

The clutch lever must be fully depressed before attempting a gear shift. Failure to fully depress the clutch lever will cause a roughstart OR stalling of the engine besides causing damage to transmission parts.

- When the vehicle is in Neutral position, press gear shift lever down with toe to engage 1st gear.

GEAR SHIFT PATTERN

1-- N -- 2 -- 3 -- 4 -- 5 -- 6

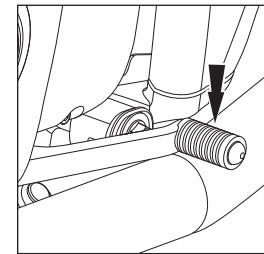

GEAR SHIFTING, RIDING AND STOPPING

CAUTION

- If the clutch lever is released abruptly and throttle opening is done insufficiently the motorcycle will have a rough start and cause the engine to stall.
- If the acceleration is very high and clutch lever is released abruptly, it will cause motorcycle to move suddenly, which will lead to loss of control leading to an accident resulting in injury and or loss of life to rider / other road users / passed by, besides damage to the motorcycle.
- Always exercise utmost caution while releasing clutch and riding the motorcycle.
- Lift gear shift lever up with toe to shift to 2nd and subsequent gears.
- As soon as the motorcycle reaches a speed of 20 kmph in 1st gear position, shift to 2nd gear and to higher gears as the speed of the motorcycle increases.

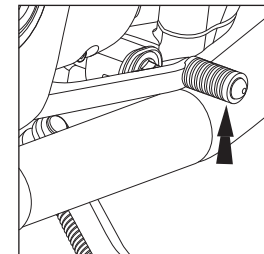

GEAR SHIFTING, RIDING AND STOPPING

NOTE

Always start motorcycle with the gear in neutral position.

When the engine speed decreases or while climbing a gradient or running at a reduced speed, shift to the appropriate lower gear to prevent the engine from stalling or straining to pull.

- Always shift to lower gears as appropriate whenever slowing down to stop the vehicle.
- Shift gears to neutral position just before bringing the vehicle to a complete stop always.
- Close throttle fully and release the clutch lever slowly ensuring the motorcycle is in neutral position and neutral lamp is glowing.
- Stop the the motorcycle in a safe place, turn "OFF" ignition and switch "OFF" engine kill switch.

PARKING

PARKING MOTORCYCLE ON CENTRE STAND

- Select a firm, flat surface.
- Hold handle bar firmly in a straight position.
- Lower centre stand, such that, both the legs of the stand are resting on a firm ground.
- Apply pressure on the fulcrum lever on the centre stand and pull the motorcycle backward.
- Lock the steering and ensure the handle bar is locked firmly before removing the key from the ignition barrel.

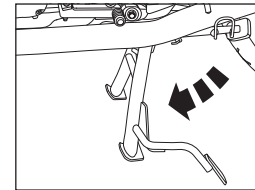

PARKING

PARKING MOTORCYCLE ON SIDE STAND

- Select a firm, flat surface.
- Extend side stand. Tilt the motorcycle to the left side, till it is supported firmly on the ground.

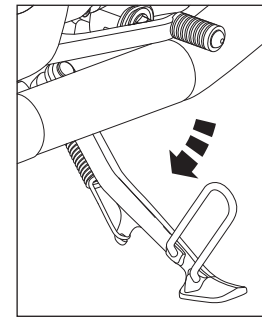

⚠ WARNING

Ensure both stands are fully retracted before riding the motorcycle.

Please exercise extreme care while parking and ensure it is parked on a firm and flat surface to avoid the motorcycle from falling over and causing injury to you or to others and damage to the motorcycle parts.

TOOLS KIT

The tool kit is located in the right side panel of the motorcycle.

S.No.	Description	Qty.
1.	C Spanner	1
2.	Allen Key 6mm	1
3.	Allen Key 5mm	1
4.	Allen Key 4mm	1
5.	Extension Tube	1
6.	Ring Spanner 24 x 14 Combination	1
7.	Screwdriver 06 x160	1
8.	Double End Spanner 10 x12	2

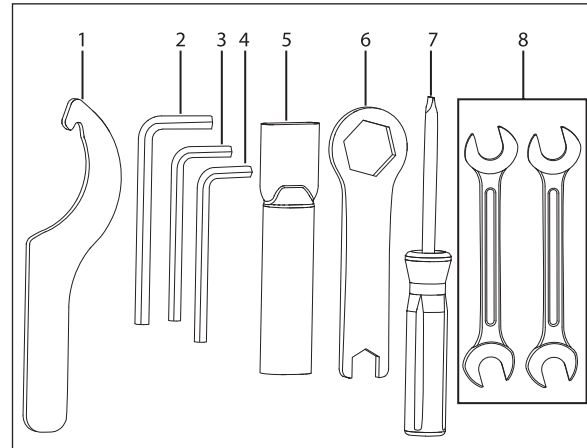

FIRST AID KIT

A first aid kit is provided with the motorcycle for any emergency requirements.

S.No.	Description	Qty.
1.	Antiseptic cream 5 gms	1
2.	Wash proof plaster 1.9 cm x 7.2 cm	2
3.	Gauze bandage 5 cm x 2 cm	1
4.	Sterilized Gauze Swab 5 cm x 5 cm	2
5.	Sterilized elastic plaster 7 cm x 6 cm	1
6.	Elastic Gauze bandage 8 cm x 1 mtr.	1
7.	First aid kit pouch	1

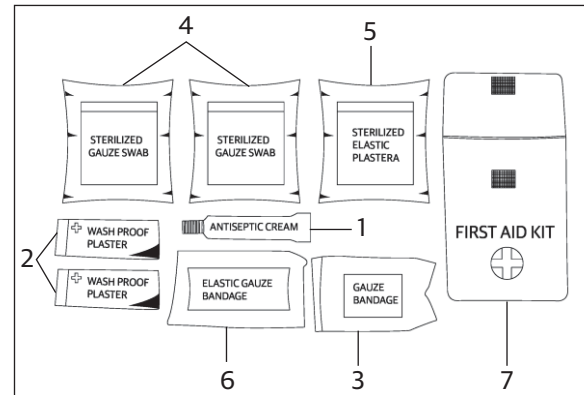

* Please familiarise yourself with the minor maintenance of the motorcycle before attempting to carry out the same.

MINOR MAINTENANCE TIPS

The following simple maintenance activities will help maintaining your motorcycle. However, for an complete maintenance, we recommend you to get in touch with a Royal Enfield Authorised Service Centre.

HAND LEVERS, CENTRE AND SIDE STAND PIVOTS

- Clean the pivot points and ensure they are free of any dirt, grime, rust, etc.
- Lubricate the pivots.

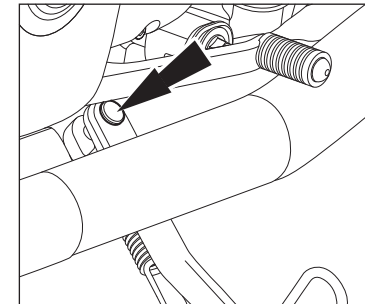

NOTE

Wipe off the excess lubricant to prevent dirt and grime from accumulating.

MINOR MAINTENANCE TIPS

DRIVE CHAIN

- Spray drive chain with recommended chain cleaning solvent while simultaneously rotating rear wheel.
- Ensure the drive chain has been sufficiently and completely covered with the cleaning solvent. If necessary use a suitable brush to remove hard deposits from the chain.
- Wait for a few minutes and clean the chain thoroughly from any dirt, grime, etc.
- Rotate rear wheel slowly and simultaneously apply recommended chain lubricant on the chain links.
- Wipe off excess chain lubricant after a few minutes with a clean cloth.

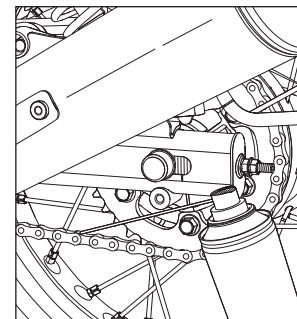
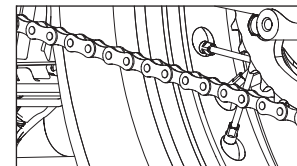

MINOR MAINTENANCE TIPS

OIL LEVEL INSPECTION

- Ensure motorcycle is in upright position on a firm and flat surface on its centre stand.
- Start the engine and allow it to run in idling rpm for about 2 minute and switch off the ignition.
- Wait for 2 minute for the oil to settle down and check oil level through the window on RH cover of the engine.
- The level is correct only if the oil is found between the "MIN" and "MAX" marks on the cover RH.
- If necessary top up ONLY with recommended engine oil till the level is between the "MIN" and "MAX" markings.

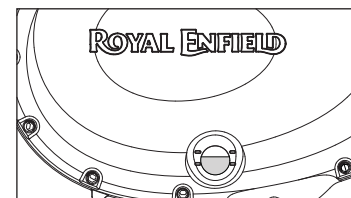

CAUTION

Use of wrong grade or spurious oils can seriously affect motorcycle performance and damage to moving parts. DO NOT over fill beyond the "MAX" level or allow oil level to drop below the "MIN" level.

MINOR MAINTENANCE TIPS

- Remove the engine oil filler cap for adding the engine oil.

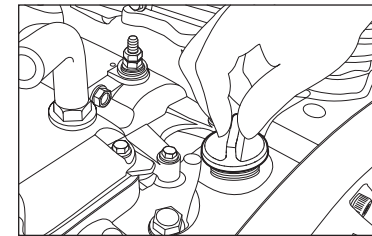

- Place a clean tray under the engine oil magnetic drain plug. Remove it along with the washer to drain oil completely from the engine.

 **WARNING**

DO NOT spill the engine oil. Store used oil in a separate container and dispose it. Avoid skin or body contact with the oil. Promptly wash the affected areas with soap and water till it is cleaned thoroughly.

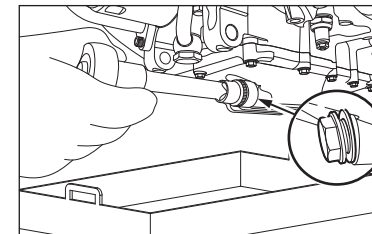

MINOR MAINTENANCE TIPS

NOTE

Ensure the engine oil is drained completely. Drain the oil completely and to avoid oil spilling.

ENGINE OIL FILLING

- Place a container under engine oil drain bolt.
- Gently apply thread sealant on drain plug thread.
- Insert the drain plug bolt along with new washer.
- Tighten the drain plug bolt to 35 Nm.
- Refill the engine oil recommended level.
- Close engine oil filler cap.
- Start and warm up engine for 2 to 3 minutes and then turn it off. Check oil level through oil level window.

CAUTION

DO NOT over fill engine oil as excess oil will spill over through the crankcase breathing system and clog the air filter.

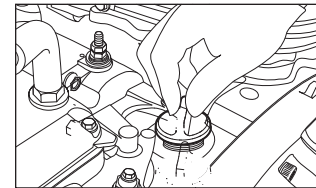
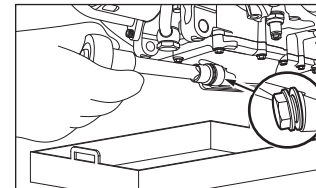

MINOR MAINTENANCE TIPS

SPARK PLUG

CLEANING SPARK PLUG AND ADJUSTING GAP

- Disconnect spark plug caps from the spark plugs.
- Locate spark plug spanner on the spark plug, loosen spark plug and remove it from cylinder head.
- Check spark plug for carbon deposits and centre electrodes for uneven wear.
- Clean spark plug by positioning it in a spark plug cleaning machine.
- Remove spark plug from the cleaning machine, check and set electrode gap between 0.7 to 0.8 mm.
- Position spark plug in the spark plug testing machine and check for proper functioning of the spark plug.
- Always replace spark plugs ONLY as per recommended specification.
- Apply a thin film of "anti seize" on the spark plug mounting and threads fix the spark plug by hand tightening.
- Tighten spark plug to torque 10 to 15 Nm by using a spark plug spanner.

Gap 0.7 to 0.8 mm.



MINOR MAINTENANCE TIPS

BRAKE FLUID FRONT AND REAR

- Ensure motorcycle is upright on a firm flat surface on its centre stand.
- Check brake fluid level in the window on front and rear reservoirs.
- The level is correct if the oil level is between the "MIN" and "MAX" marks.
- Open the reservoir cover and remove diaphragm carefully to top up the brake fluid.
- Top up only with DOT 4 brake fluid until level is between "MIN" and "MAX" marks in the reservoir.
- Replace diaphragm correctly and close cover firmly.
- Wipe off any excess / spilled brake fluid immediately with a clean cloth.

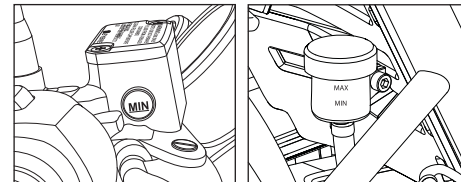

Front Brake

Rear Brake

CAUTION

Brake fluid is highly corrosive and can cause damage to painted parts. Please ensure that brake fluid does not spill on any part of the motorcycle. In the event of a spill, please clean the area immediately with a soft wet cloth to avoid damage to the affected part.

DO NOT mix different brake fluid grades. Use ONLY DOT 4 Brake fluid.

MINOR MAINTENANCE TIPS

INSPECTION OF TYRES AND WHEELS

- Inspect the tyres periodically for tread wear, cracks and cuts.

Minimum tread depth :	
Front tyre : 1 mm	Rear tyre : 2 mm

- Check and remove stone, splinters, nails or other particles embedded in the tyre treads.
- Periodically inspect wheels for spokes damage and wheel rim for wobbling or run out.
- Check uniform seating of the tyre beading on the rim whenever the tyre is reassembled.
- Use only recommended tyres and tubes, inflated to correct air pressure as given below.

	Front	Rear
Solo	32 psi/2.20 kg/cm ²	36 psi/2.53 kg/cm ²
With Pillion	32 psi/2.20 kg/cm ²	39 psi/2.74 kg/cm ²

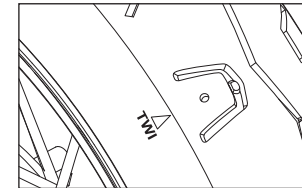

MINOR MAINTENANCE TIPS

FRONT WHEEL REMOVAL

- Ensure motorcycle is upright on a firm and flat surface.
- Place a wooden block on the front end of engine to support the motorcycle and ensure front wheel is off the ground by minimum 2 inches.
- From wiring harness RH side disconnect the speedo drive coupler.
- Loosen the pinch bolt on the front fork bottom right side.
- Remove the axle nut along with washer, hold the wheel axle on the right side and loosen hex nut on the left completely.
- Remove axle nut and washer from wheel axle.

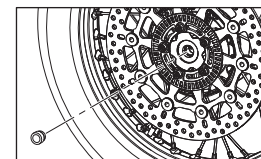
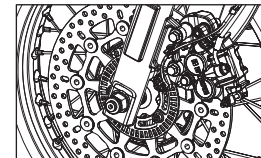
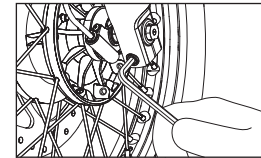

MINOR MAINTENANCE TIPS

- Tap and remove the front wheel spindle, gently tap axle from left side while supporting wheel at the bottom then remove axle from the right side.

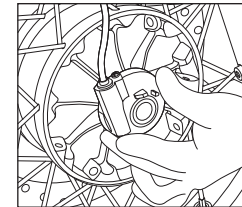

CAUTION

Take care to secure the wheel spacers and speed sensor while removing the axle from the forks.

- Slide out the front wheel from the forks.

CAUTION

Do not press the brake lever when front wheel is removed as this will result in the brake pads coming too far out of the brake caliper.

- Place a 4 mm thick wooden piece or cardboard sheet between the brake pads to avoid pads activation in the event the front brake lever is accidentally pressed.
- Take care not to damage the front brake disc or tonering as it will affect the braking system and ABS.

MINOR MAINTENANCE TIPS

FRONT WHEEL REASSEMBLY

- Remove the wooden piece / cardboard sheet placed between the brake pads
- Locate speedo drive to its correct position on the right side.
- Locate stepped spacer to the wheel hub on left side.
- Insert the wheel along with speedo drive and spacer between the fork ends. Ensure the brake disc is located between the brake pads.
- Support front wheel at the bottom and ensure the mounting holes are aligned to insert the wheel axle along the right side fork end. Gently tap axle into wheel till the threaded portion of axle is fully visible on the left side fork end.
- Assemble washer and nut on axle.
- Hold the wheel axle firmly on right side and tighten axle nut firmly on right side to a torque of 70 Nm.
- Tighten pinch bolt completely on fork end to a torque of 25 Nm.

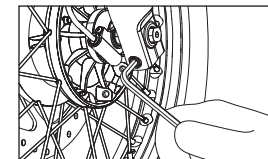
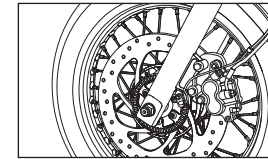
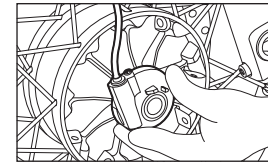

MINOR MAINTENANCE TIPS

- Rotate wheel to check for smooth rotation.
- Connect the speedo wire coupler and check for proper working of speedometer.
- Press brake lever and check front brake efficiency.

CAUTION

Please exercise utmost caution while reassembling the front wheel on the motorcycle.

please ensure the wheel is fitted correctly before attempting to ride the motorcycle.

Failure to do so may result in the motorcycle not performing correctly, may lead to an accident causing injury to you / other road users and may lead to loss of life.

MINOR MAINTENANCE TIPS

REAR WHEEL REMOVAL

- Ensure motorcycle is upright on a firm and flat surface with the rear wheel at least 6 inches raised above from the surface.
- Observe and mark the alignment indexes on both chain adjuster on left and right side swing arm.
- Loosen the lock nuts and adjuster nuts fully on the left and right side chain adjuster.

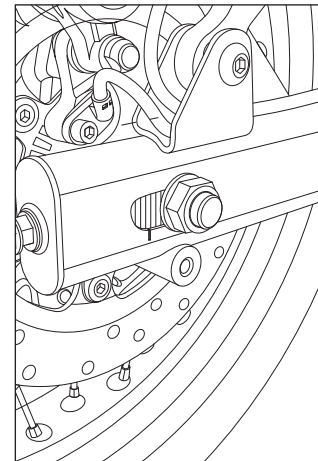

MINOR MAINTENANCE TIPS

- Hold wheel spindle on left side firmly and loosen hex nut on right side.
- Remove the nut and washer from the wheel spindle.
- Push rear wheel fully into the swing arm.
- Support rear wheel from bottom and pull out wheel spindle from the left side swing arm from the clips on swing arm.
- Release the brake hose gently and remove caliper assembly from swing arm on right side.

CAUTION

- Ensure brake hose does not get damaged or kinked while removing.
- Support caliper assembly suitably and away from swing arm.
- Release the chain from the sprocket and ensure it does not get jammed or damaged when removing rear wheel.
- Remove support from wheel bottom and gently slide out rear wheel from the swing arm with rear sprocket, brake disc and spacers.

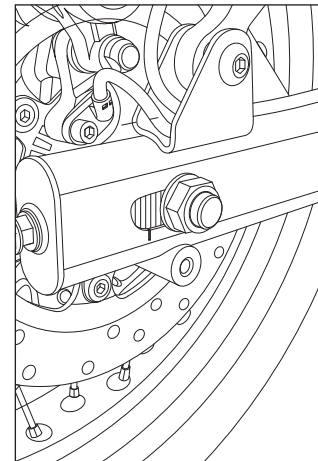

MINOR MAINTENANCE TIPS

CAUTION

Do not press the rear brake pedal when the rear wheel is being removed as this will cause the brake pads to dislocate from the brake caliper.

- Place a 4 mm thick wooden piece or cardboard sheet between the brake pads to avoid activation of brake pads if rear brake pedal is accidentally pressed.

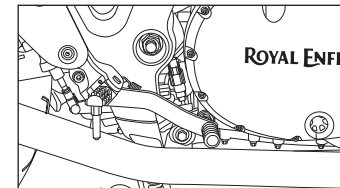

CAUTION

DO NOT pull up the rear brake pedal to lift or raise the motorcycle for any reason.

MINOR MAINTENANCE TIPS

REAR WHEEL REASSEMBLY

- Ensure that the long stepped spacer is located on the brake disc side and the short spacer is located on the sprocket side of the wheel hub firmly.
- Ensure that the chain adjuster are located properly inside the swing arm left and right sides.
- Locate caliper assembly on the tab along the swing arm right side.
- Locate rear wheel with the sprocket to the left side ensuring the brake disc in-between the brake pads on right side.
- Lift up the rear wheel and ensure that the slots in the swing arm brake caliper bracket holes in chain adjusters and the centre hole in the hub are aligned.
- Support rear wheel suitably and insert rear wheel spindle along the left side swing arm into the wheel hub.
- Ensure that the long stepped spacer is located along the brake side and the short spacer is located along the sprocket side on the wheel hub.

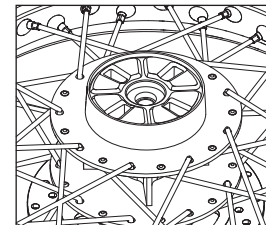
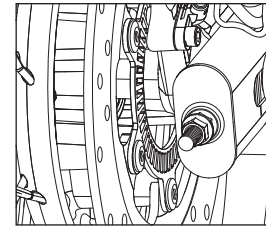

MINOR MAINTENANCE TIPS

- Tap spindle gently into wheel hub slot till the threads are completely visible on the right side.
- Assemble the drive chain on the sprocket and ensure it is seated correctly.
- Check for free and smooth rotation of the rear wheel.
- Assemble washer and hex nut on wheel spindle on right side.

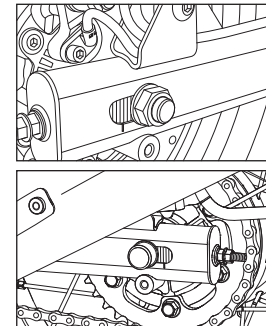

MINOR MAINTENANCE TIPS

DO NOT TIGHTEN HEX NUT FULLY

- Tighten chain adjuster nuts on left and right adjuster such that the index marks are aligned correctly on both sides of the swing arm.
- Check and ensure correct chain tension and wheel alignment.
- Hold spindle firmly on left side and tighten hex nut on right side set torque to 70 Nm.
- Locate the brake hose in the clips along the swing arm right side.
- Check rear brake for proper operating efficiency.

CAUTION

Please exercise utmost caution while reassembling the rear wheel on the motorcycle.

Please ensure the wheel is fitted correctly before attempting to ride the motorcycle.

Failure to do so will result in poor performance of motorcycle which may lead to an accident causing injury to you / other road users and may lead to loss of life.

MINOR MAINTENANCE TIPS

ADJUSTMENTS - CLUTCH

- Loosen the cable outer lock nut .
- Turn the nut clockwise to reduce the play or anticlockwise to increase the free play.
- Tighten lock nut after adjustment is done.
- Check free play 2 to 3 mm at clutch lever pivot on handle bar end, if desired free play is not achieved readjust.

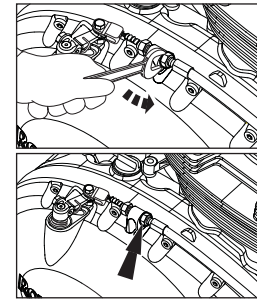

REAR BRAKE LIGHT

The brake light glows once you press the brake lever.

If brake light is not glowing, check the brake light switch wire for proper connection.

MINOR MAINTENANCE TIPS

DRIVE CHAIN TENSION (Free Play 20-30 mm)

- Park motorcycle up right on a firm and flat surface.
- Ensure the motorcycle is in neutral position.
- Measure the drive chain free play as shown. The drive chain free play is 20 mm to 30 mm.

1. If the drive chain free play is found to be incorrect adjust as follows:
 - a. Loosen the axle nut of the rear wheel axle.
 - b. Loosen the lock nut on the adjuster at both end of the swing arm.
 - c. To reduce the free play, tighten the adjuster nut on the adjuster evenly.

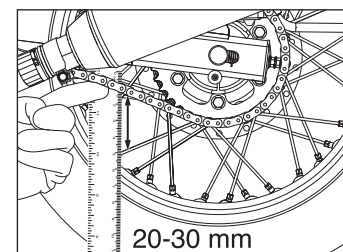

MINOR MAINTENANCE TIPS

- d. To increase the free play, loosen the adjuster nuts evenly and push the rear wheel forward.
- e. Check the chain for correct chain tension.
- f. Ensure that the index marks on the adjuster and swing arm are same on both left and right side of the swing arm.
- g. Hold spindle firmly to the left side and tighten rear hex nut to a torque of 70 Nm.
- h. Tighten the adjuster locknut using a 24mm spanner.

WARNING

Chain slackness beyond 30mm will lead to chain slippage and may also cause increased wear rates to chain and sprockets.

Maintain drive chain slackness within the specified limits at every 1000 kms interval.

Please ensure the both wheels are aligned correctly, after adjusting the chain and before tightening the rear wheel spindle nut.

MINOR MAINTENANCE TIPS

BATTERY AND MAINTENANCE

- The Motorcycle is provided with 12V - 12 Ah battery.
- The battery must be periodically checked for cleanliness and corrosion free terminals.

NOTE

The poor contact or loose fitment of battery terminals may cause ECU failure.

DISMANTLING

- Switch "OFF" the engine and remove ignition key from the key barrel.
- Disconnect battery negative (- ve) terminal bolt.

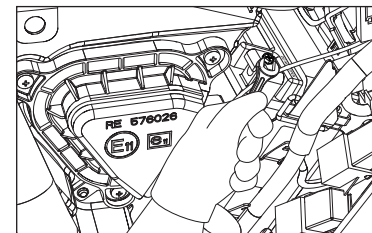
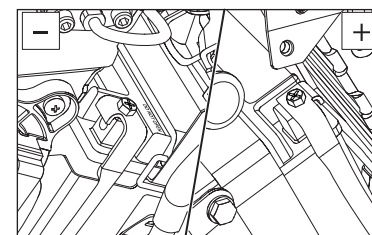

MINOR MAINTENANCE TIPS

- Remove 3 Nos. Hex head bolts from tool box to access the battery.

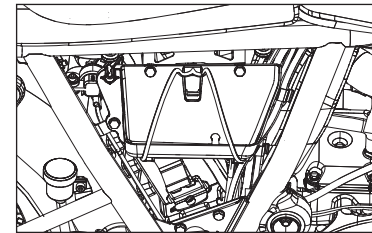

- Disconnect battery positive (+ve) terminal from battery.

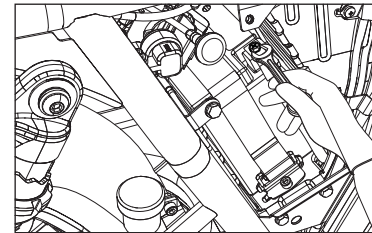

MINOR MAINTENANCE TIPS

- Pull battery strap (belt) downwards and release strap lock from battery strap bracket.

- Loosen and remove hex flange head screw from battery strap bracket.

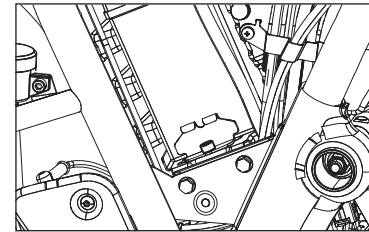
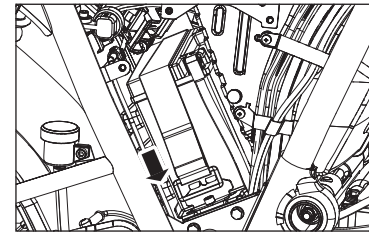

MINOR MAINTENANCE TIPS

- Remove battery strap bracket from battery tray.

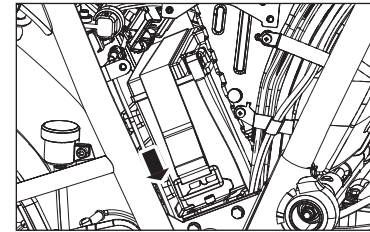

- Remove battery from tray.

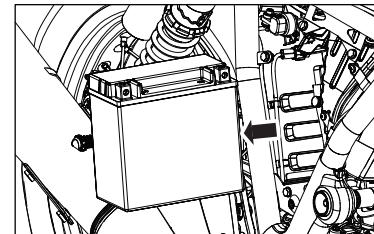

MINOR MAINTENANCE TIPS

WARNING

Always disconnect the black negative (-ve) battery cable first and then the red positive (+ve) cable while removing the battery connections.

NOTE

For checking the battery voltage contact Royal Enfield Authorised Service Centre or battery service centre.

MINOR MAINTENANCE TIPS

ASSEMBLY

- Assemble battery in to tray.

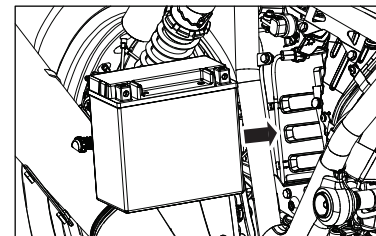

- Place battery strap bracket into battery tray.

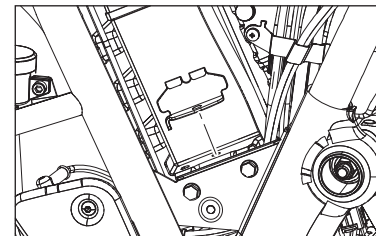

MINOR MAINTENANCE TIPS

- Locate and tighten flanged head screw into battery strap bracket.

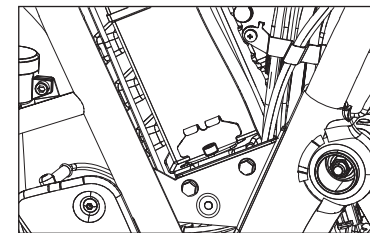

- Pull battery strap (belt) downwards to fix strap lock into battery strap bracket.

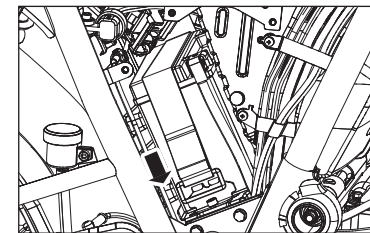

MINOR MAINTENANCE TIPS

- Connect battery red positive (+ve) terminal bolt.

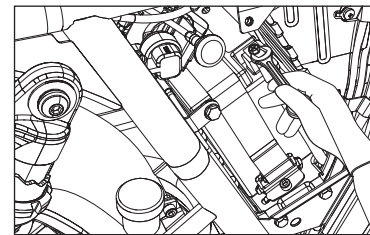

- Locate and tighten 3 nos. hex head bolts into tool holder.

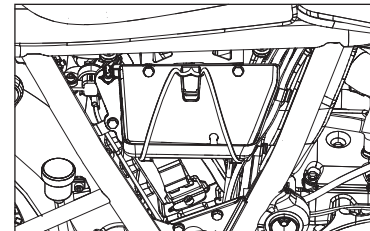

MINOR MAINTENANCE TIPS

- Connect red battery negative (-ve) terminal bolt.

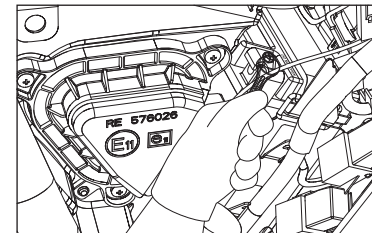

CAUTION

Connect the black (-ve) negative terminal after connect red (+ve) positive terminal only.

NOTE

Clean the wire terminals free from corrosion and keep the terminals coated with petroleum jelly.

CAUTION

Keep the red (+ve) positive terminal and (-ve) negative terminal cables firmly connected to the respective battery terminals. Failure to do so may result in damage to the motorcycle electrical system.

MINOR MAINTENANCE TIPS

CHANGING ELECTRICAL COMPONENTS

HEADLAMP BULB REPLACEMENT

- Loosen the rim holding screw on top and take out the head lamp dome.
- Disconnect electrical connections.
- Thumb push and remove the bulb holding clamp gently.
- Remove the bulb using a clean and soft cloth.

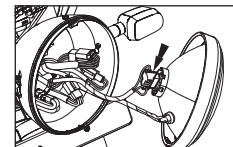
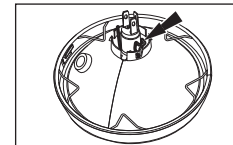
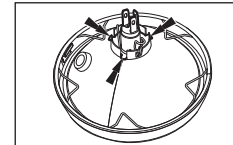

MINOR MAINTENANCE TIPS

- Position the new bulb inside the reflector such that the three projections on the bulb align with the slot on the reflector.
- Refit the bulb holding clamp.
- Connect the electrical connections.
- Position head lamp dome onto the head lamp shell and tighten the mounting screw on top.

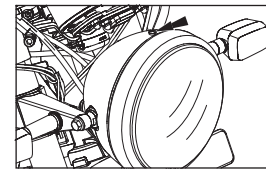

NOTE

Never touch the bulb with your fingers. Finger prints will etch the glass and decrease bulb life apart from causing burns to your fingers.

Always hold the bulb with gloves and clean dry cloth during handling.

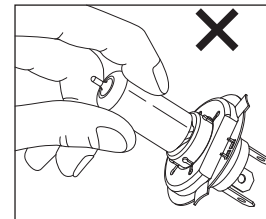

MINOR MAINTENANCE TIPS

TAIL LAMP BULB

- Unlock the side panel RH.
- Remove the seat assembly by pulling seat lock cable.
- Remove the tail light cover by unscrewing its mounting screw.
- Hold the bulb, press inside and rotate anticlockwise to remove the tail light bulb from its holder using a clean cloth.
- Replace the bulb 12V 21 / 5W using a soft clean cloth.
- Re-assemble the tail light in the reverse order of dismantling process.

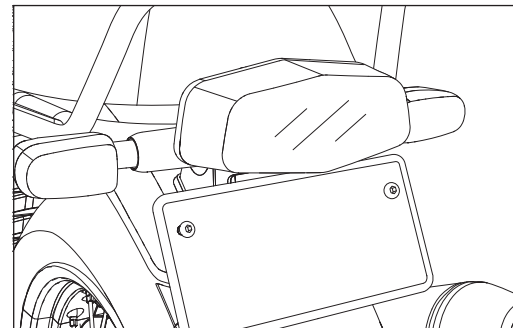

MINOR MAINTENANCE TIPS

TRAFFICATOR BULB REPLACEMENT

- Remove the screw from the trafficator housing.
- Open the indicator housing.
- Remove the bulb holder with help of a screw driver.
- Remove the bulb and replace the same using a soft and clean cloth.
- Refit the holder to its proper position.
- Fix the rubber gasket cover.
- Assemble the indicator housing cover.

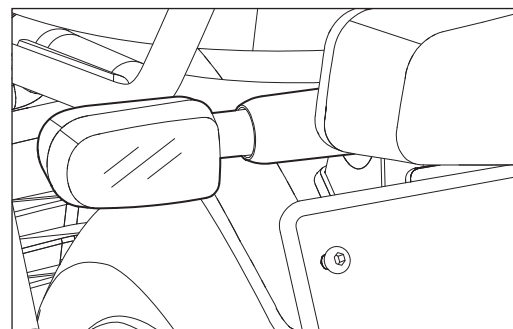

MINOR MAINTENANCE TIPS

MINI BLADE FUSE USAGE LIST

Fuse ID Number	Color	Rating	Remarks
1	V	30 A	Alternator
2	R-W	30 A	Main Fuse
3	G-W	15 A	Ignition Fuse-EFI
4	R	10 A	Signalling Fuse
5	BR	10 A	Horn Fuse

Fuse ID Number	Color	Rating	Remarks
6	R	15 A	Lighting Fuse (Head Lamp)
7	R-W	10 A	Accessory Fuse
8	R	10 A	ABS Fuse
9	R-W	25 A	ABS Fuse

WARNING

Please get the electrical system of your motorcycle checked thoroughly and get the faults corrected immediately after experiencing any fuse failure. Failure to do so may result in repeated fuse failure.

Usage of fuses other than specified rating will damage the complete electrical system.

MINOR MAINTENANCE TIPS

AIR FILTER

CLEAN AND REFIX : EVERY 5000 kms

- Remove the screw from the side panel bottom side and remove side panel.
- Remove the air filter cover screws and then take out air filter box cover.
- Pull out filter element and check for dirt. Clean filter element carefully.

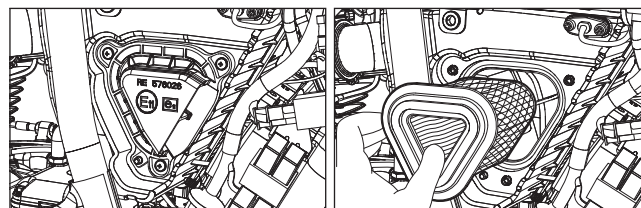

NOTE

Usage of high pressure compressed air is not recommended to clean air filter element.

Fitment of air filter element is in the reverse order of removal process.

LONG TRIP PRECAUTIONS

CHECKS PRIOR TO THE COMMENCEMENT OF A LONG JOURNEY

- Service the motorcycle at Royal Enfield Authorised Service Centre.
- Ensure sufficient quantity of fuel is always available in the fuel tank for the journey planned.
- Check and correct tyre pressure if necessary.

CHECKS AFTER EVERY 1500 KMS OF RUN

- Any loose fasteners.
- Condition of the tyres.
- Correct oil level in engine.
- Working of all lights and horn.
- Proper drive chain tension.
- Clutch cable free play.

LONG TRIP PRECAUTIONS

ITEMS TO BE CARRIED

- Tools kit.
- Bulbs for headlight, trafficator light and mini blade fuses (10 and 15 A).
- Accelerator and clutch cable.
- Spark plug, spark plug cap.
- Spare tubes.

WASHING PROCEDURE

PRECAUTIONS

- Remove ignition key and seal the ignition key barrel slot using adhesive tape.
- Cover the silencer tail pipe, horn and control switches with suitable plastic bags and tie it firmly to prevent water entry.
- Wash the motorcycle only when the engine is in cold condition.
- Do not remove side panel while washing to avoid water entry.
- Brush engine area with a recommend non corrosive solvent to remove dirt or grease.
- Use low pressure water jet to clean.
- Never spray water with great force on head lamp, meter/cluster unit, flasher lights, front and rear wheel hubs, electrical connections and wires, control cables, EFI components, spark plug, battery, side panels.
- Do not apply any corrosive solvent on painted surfaces or rubber parts.
- Use lukewarm water and mild detergent on the painted components to remove dirt, etc.
- Clean motorcycle thoroughly with plain water to remove the detergent.

WASHING PROCEDURE

- If possible, use compressed air and blow off water particles from the obscure areas of the motorcycle, electrical connections etc.

AFTER WASHING

- Ensure, the motorcycle is thoroughly dry by wiping with a clean soft lint free absorbent cloth or chamois leather.
- Remove all adhesive tapes.
- Lubricate control cables, pivots for footrest, side stand, centre stand, brake and gear shifter linkages, drive chain etc. with lube oil.
- Polish the painted and plated surfaces using recommended automobile polishing wax.
- Start the engine and allow to run at an idling speed for a few minutes to warm up engine.
- Drive the motorcycle slowly, apply both the brakes intermittently to dry up the water in brake pads.

STORAGE PRECAUTIONS

In-case your motorcycle is not going to be used for a month or more, the following precautions should be taken.

- Get the motorcycle serviced through a Royal Enfield Authorised Service Centre.
- Drain the fuel completely from the fuel tank and induction system
- Remove spark plug. Pour in about 5ml of clean engine oil through spark plug hole. Close the hole and crank engine several times and refit spark plug.
- Clean drive chain thoroughly and apply Royal Enfield recommended chain lubricant.
- Wipe off excess lubricant after 5 minutes of application
- Remove battery from the motorcycle. Clean the terminals to free from corrosion and apply petroleum jelly to terminals and cover both them using a plastic sheet.
- Store the battery in a cool, dry and well ventilated place.
- Cover the silencer with suitable bags to prevent moisture entry. Set the motorcycle on its centre stand.
- Apply anti rust solutions on all plated parts. Take care not to apply this solution on chrome, rubber or painted parts. Store motorcycle in a clean covered area free of moisture and dust.
- For re-use after storage, it is preferable to get the motorcycle prepared through a Royal Enfield Authorised Service Centre to ensure the motorcycle is restored to its peak operating conditions.

TROUBLE SHOOTING

WARNING

The trouble shooting section of this Owner's Manual is intended solely as a guide for diagnosing problems. Carefully read the appropriate sections of this manual before performing any work, repair and maintenance operations not listed in this Owner's Manual should be performed by your Royal Enfield Authorised Service Centre only. Improper repair / maintenance will result in the motorcycle not functioning properly or serious injury.

WARNING

Please get the electrical system of your motorcycle checked thoroughly and get the faults corrected immediately after experiencing any fuse failure. Failure to comply can result into repeated fuse failures. Usage of fuses other than specified rating will damage the complete electrical system.

CAUSES

REMEDIES

I. ENGINE FAILS TO START

- | | |
|---|-------------------------------|
| 1) Ignition switch in "OFF" position | Turn Ignition switch "ON". |
| 2) Engine kill switch in "OFF" position | Kill switch to "ON" position. |

* Contact Royal Enfield Authorised Service Centre

TROUBLE SHOOTING

CAUSES	REMEDIES
3) No fuel in fuel tank	Refill fuel.
4) Battery low voltage indicator is glowing continuously	Check battery for voltage / charging circuit.
5) Engine Malfunction indicator is glowing continuously	Get the motorcycle inspected through a Royal Enfield Authorised Service Centre.
6) Spark plug cap / lead not connected	Fix cap / lead firmly.
7) Spark plug electrode dirty / fouled	Clean spark plug
8) Spark plug insulation cracked	Replace spark plug.
9) Main or EFI fuse blown out	Replace with new fuse.

* Contact Royal Enfield Authorised Service Centre

TROUBLE SHOOTING

CAUSES

REMEDIES

II. ENGINE MISFIRING

- | | |
|---|--|
| 1) Loose spark plug cap | Fix cap firmly. |
| 2) Spark plug fouled | Clean spark plug or non specified heat range plug. |
| 3) Any sensor loose connections | * Check MAP or EOT or TPS sensor wiring / coupler loose connections. |
| 4) Water in fuel tank | * Clean fuel tank. Fill tank with fresh petrol. |
| 5) Engine starts but shuts of immediately | Check if the MIL indicator continuously is glowing; If yes* |
| 6) Engine misfires and runs erratically | Check if the MIL indicator continuously is glowing; If yes* |

* Contact Royal Enfield Authorised Service Centre

TROUBLE SHOOTING

CAUSES

REMEDIES

III. POOR PICKUP

- | | |
|---|---|
| 1) Brake pedal adjusted too tight | *Re-adjust properly, refer to respective section. |
| 2) Choked air filter | Clean / Replace air filter. |
| 3) Drive chain tigh | *Re-adjust properly. |
| 4) Under inflated tyres | *Inflate to correct pressure. |
| 5) Accelerator cable free play excessive | Adjust accelerator cable free play. |
| 6) Clutch slipping | *Adjust clutch cable free play. |
| 7) Faulty fuel supply, fuel pump, filter / injector blocked | *Remove fuel pump and clean. |
| 8) Poor pickup | Check if the MIL indicator is glowing; If yes* |

* Contact Royal Enfield Authorised Service Centre

TROUBLE SHOOTING

CAUSES

REMEDIES

IV. ENGINE OVERHEATING

- | | |
|------------------------------|---|
| 1) Low engine oil level | Check and top-up if necessary. |
| 2) Clutch slipping | * Check and correct. |
| 3) Cylinder fins not clogged | Clean the cylinder fins at regular intervals. |

V. EXCESSIVE FUEL CONSUMPTION

- | | |
|-------------------------|---|
| 1) Under inflated tyres | Inflate to correct pressure. |
| 2) Choked air filter | Clean / Replace. |
| 3) Fuel leakage | *Check and rectify, tank float unit, drain pipe, breather pipe, fuel line, pump, EVAP system. |

* Contact Royal Enfield Authorised Service Centre

TROUBLE SHOOTING

CAUSES

REMEDIES

VI. BRAKES POOR

- | | |
|---------------------------------|---|
| 1) Brake pad worn / Uneven wear | *Replace brake pads. |
| 2) Oil / grease on disc. | *Clean and refit. |
| 3) Spongy brake | *Fill brake fluid and perform brake bleeding. |

VII. MOTORCYCLE WOBBLER

- | | |
|-------------------------------|------------------------------|
| 1) Under inflated tyres | Inflate to correct pressure. |
| 2) Loose / Broken spokes | * Tighten / Replace spokes. |
| 3) Wheels misaligned | * Ensure proper alignment. |
| 4) Wheel rim runout | * Rectify. |
| 5) Tyres not fitted correctly | * Refit tyres correctly. |

* Contact Royal Enfield Authorised Service Centre

TROUBLE SHOOTING

CAUSES

REMEDIES

VIII. ELECTRICALS

Bulbs do not glow

- | | |
|--------------------------------|---------------------------|
| 1) Bulb fused | * Replace bulb. |
| 2) Fuse blown | * Check and replace fuse. |
| 3) Loose / improper connection | * Check and correct. |

Horn not working

- | | |
|----------------------|--------------------|
| 1) Fuse blown | Check and correct. |
| 2) Loose connections | Check and correct. |

Trafficators not working

- | | |
|---------------------------------|--------------------|
| 1) Loose / improper connections | Check and correct. |
| 2) Bulb fused | Replace. |

* Contact Royal Enfield Authorised Service Centre

TROUBLE SHOOTING

CAUSES

REMEDIES

IX. ELECTRONIC FUEL INJECTION (EFI)

Malfunctioning indicator lamp (MIL) glowing continuously

- | | |
|------------------------------------|---|
| 1) Sensor coupler loose connection | * Check for all EFI sensor coupler loose connection and correct them. |
| 2) Any EFI sensor failure | * Check and replace the same. |

X. ABS (ANTI LOCK BRAKING SYSTEM)

- | | |
|------------------------------------|---|
| 1) ABS indicator continuously "ON" | Take the vehicle to service centre for diagnosis. |
|------------------------------------|---|

* Contact Royal Enfield Authorised Service Centre

PERIODICAL MAINTENANCE

The maintenance schedule detailed here will help you to maintain your interceptor INT 650 motorcycle meticulously to get a long trouble free service. The schedule provided herein is based upon an average riding conditions and indicates the km/miles at which regular inspections, adjustments, replacements and lubrications are to be carried out. The frequency of the maintenance must be shortened depending upon the severity of the driving condition or if the motorcycle is used in a very dust environment. Contact the nearest Royal Enfield Authorised Service Centre for expert advice and to carry out the required maintenance.

Sl. No.	DESCRIPTION	PERIODIC MAINTENANCE											
		Kms (x 1000)											
		0.5	5	10	15	20	25	30	35	40	45	50	
	Months	1.5	6	12	18	24	30	36	42	48	54	60	
1	Engine Oil (#)	R		R		R		R		R		R	
		Check level at every 1000 Kms or earlier and top up as required											
2	Engine oil filter element (#)	R		R		R		R		R		R	
3	Inlet and Exhaust valve clearance (**)	I		I		I		I		I		I	
4	Spark plug	I	I	I	I	R	I	I	I	R	I	I	
5	HT lead for crack	I	I	I	I	I	I	I	I	I	I	I	

I - Inspect (Clean, Adjust, lubricate or replace if necessary)

L - Lubricate

R - Replace

C - Clean

(#) - After First service, Engine oil and Engine oil filter replacement is a mandatory at every 12 months even the vehicle has not covered the specified kms.

(**)- After First service, Valve clearance adjustment is a mandatory at every 12 months even the vehicle has not covered the specified kms.

PERIODICAL MAINTENANCE

Sl. No.	DESCRIPTION	PERIODIC MAINTENANCE											
		Kms (x 1000)	0.5	5	10	15	20	25	30	35	40	45	50
	Months	1.5	6	12	18	24	30	36	42	48	54	60	
6	Rubber hose, Air filter to Throttle body	I	I	I	I	I	I	I	I	I	I	I	
7	Rubber hose, Inlet manifold/ Adaptor	I	I	I	I	I	I	I	I	I	I	I	
8	Evaporative Emission Equipment rubber hoses	I	I	I	I	I	I	I	I	I	I	I	
9	Fuel filter - External					R				R			
10	Air filter element	C	C	R	C	R	C	R	C	R	C	R	
		Clean/replace more frequently if operated in dusty condition											
11	Vent Pipe under air filter box	I	I	I	I	I	I	I	I	I	I	I	
12	Hose - Secondary Air	I	I	I	I	I	I	I	I	I	I	I	
13	Accelerator and Throttle pulley cables free play	A	A	A	A	A	A	A	A	A	A	A	
14	Clutch Cable / lever free play	Adjust every 1000 Kms or earlier as required											
15	Hand levers pivot point	Lubricate every 1000 Kms or earlier as required											

I - Inspect (Clean, Adjust, lubricate or replace if necessary)

L - Lubricate

R - Replace

C - Clean

(#) - After First service, Engine oil and Engine oil filter replacement is a mandatory at every 12 months even the vehicle has not covered the specified kms.

(**)- After First service, Valve clearance adjustment is a mandatory at every 12 months even the vehicle has not covered the specified kms.

PERIODICAL MAINTENANCE

Sl. No.	DESCRIPTION	PERIODIC MAINTENANCE											
		Kms (x 1000)	0.5	5	10	15	20	25	30	35	40	45	50
	Months	1.5	6	12	18	24	30	36	42	48	54	60	
16	Brake pads - Front and Rear	I	I	I	I	I	I	I	I	I	I	I	
17	Disc Brake fluid level - Front and Rear	I	I	I	I	R	I	I	I	R	I	I	
18	Rear brake pedal and Gear change pedal pivot	L	L	L	L	L	L	L	L	L	L	L	
19	Brake hose and Banjo Bolt - Front and Rear	I	I	I	I	I	I	I	I	I	I	I	
20	Front Fork oil leak	I	I	I	I	I	I	I	I	I	I	I	
		Replace oil at every 60000 kms or any work carried out whichever is earlier											
21	Steering tapper roller bearing Play	I	I	I	I	I	I	I	I	I	I	I	
22	Rear Wheel Drive Chain	Lubricate and Adjust every 1000 Kms / Clean, Lubricate and Adjust every service or earlier as required											
23	Rear wheel Cush rubbers				I				I				
24	Spokes tightness / Wheel rim run out front and rear	I	I	I	I	I	I	I	I	I	I	I	

I - Inspect (Clean, Adjust, lubricate or replace if necessary)

L - Lubricate

R - Replace

C - Clean

(#) - After First service, Engine oil and Engine oil filter replacement is a mandatory at every 12 months even the vehicle has not covered the specified kms.

(**)- After First service, Valve clearance adjustment is a mandatory at every 12 months even the vehicle has not covered the specified kms.

PERIODICAL MAINTENANCE

SI. No.	DESCRIPTION	PERIODIC MAINTENANCE											
		Kms (x 1000)	0.5	5	10	15	20	25	30	35	40	45	50
	Months	1.5	6	12	18	24	30	36	42	48	54	60	
25	Battery terminals (apply petroleum jelly)	C	C	C	C	C	C	C	C	C	C	C	
26	Battery electrolyte levels (Not applicable for sealed battery)	I	I	I	I	I	I	I	I	I	I	I	
27	Earth wire eyelet tightness			I		I		I		I		I	
28	Tyre wear pattern front and rear	I	I	I	I	I	I	I	I	I	I	I	
29	Pivot-Side Stand, Centre Stand	L	L	L	L	L	L	L	L	L	L	L	
30	Rider and Pillion Foot rest pivot	L	L	L	L	L	L	L	L	L	L	L	
31	All mounting fasteners in vehicle for tightness	I	I	I	I	I	I	I	I	I	I	I	

I - Inspect (Clean, Adjust, lubricate or replace if necessary) L - Lubricate R - Replace C - Clean

(#) - After First service, Engine oil and Engine oil filter replacement is a mandatory at every 12 months even the vehicle has not covered the specified kms.

(**)- After First service, Valve clearance adjustment is a mandatory at every 12 months even the vehicle has not covered the specified kms.

NOTE

For Maintenance after 50,000 Kms, Please repeat the same frequency specified above, in consultation with a Royal Enfield Authorised Dealer / Service Centre.

WARRANTY TERMS AND CONDITIONS

Royal Enfield Motorcycles are manufactured by following best Quality practices in respect of the material and workmanship.

Royal Enfield (RE) warrants its motorcycle to be free from manufacturing and material defect under normal use subject to following conditions.

1. RE will replace or repair defective part(s) at their Dealerships and Authorised Service Center, free of charge within a period of 36 months / 40,000 kms. from the date of sale, whichever is earlier and 36 months inclusive RSA (Road Side Assistance).
2. In order to avail warranty benefits by second or subsequent owner, the second/subsequent owner should inform the nearest Royal Enfield Service Center about the purchase of the bike and shall fill in the requisite details in the form as requested by Royal Enfield.
3. The warranty shall be applicable only if all the 4 free services & 5 paid services are availed in the respective period/kilometer ranges as per the schedule in the owner's manual from RE Authorised Dealer / Service Center.
4. During the warranty period, RE's obligations shall be limited to repairing/replacing part(s) of the motorcycle for free, only if the part(s), on examination is deemed to have a manufacturing defect. Defective part(s) which have been replaced will become the sole property of RE.

WARRANTY TERMS AND CONDITIONS

5. Cost of oil, oil filter and fuel are chargeable to the customer.
6. Claims on proprietary items like tyres, tubes, spark plug, battery etc. should be taken up with the respective manufacturer or their authorised agents in the area directly by the customer. RE shall not be liable in any manner to replace them through their dealers. RE will, however, provide assistance in preferring such claims on the respective manufacturer.
7. Warranty shall not apply to:
 - (a) Normal ageing, deterioration or rusting of plated parts, paints coat, rubber parts, soft items, glass items, plastic parts etc.
 - (b) Components like fuel filter, oil filter, Air filter paper element, control cables, brake shoes / brake pads, clutch plates, drive chain & sprocket kit, Steering ball races, Electrical equipment, wiring harness etc., which are subjected to normal wear and tear.
 - (c) Failures occurred due to use of non recommended grade lubricants, fuel or improper level.
 - (d) Damages due to use of non-genuine parts, lack of proper maintenance, incorrect riding habits.
 - (e) Parts damaged due to accidents, collision, abuse etc.

WARRANTY TERMS AND CONDITIONS

- (f) Irregularities not recognised as affecting the quality or function of the motorcycle such as slight vibration, oil leakage, discoloration of exhaust bent pipe/silencer/soft or hard shockabsorber etc.
 - (g) Defects arising from fitment of unauthorised or additional electrical loads.
 - (h) Motorcycle serviced or repaired at unauthorised service centers.
 - (i) Motorcycle used for competitions / racing / Stage Rallying etc.
 - (j) Electrical component like bulbs, fuses etc. and electronic components failure including ECU due to repairs by arc welding.
 - (k) Motorcycle found with tampering / drilling / welding mark on any part of the Frame.
 - (l) Normal maintenance operations like adjustment of brakes, cleaning fuel system, engine tune-up and other such adjustments.
 - (m) Oxidization of buffed/painted/powder coated items etc.
8. RE reserves the right to finally decide on all warranty claims.
9. RE reserves the right to make changes in design of the motorcycle without any obligation to install these changes on previously supplied motorcycles.

EMISSION WARRANTY

In compliance with the provisions of Rule 115(2) of the Central Motor Motorcycle Rules, 1989, Royal Enfield certifies that the following warranty is applicable to those components liable to affect the emission of the gaseous pollutants in its range of motorcycle, in normal use to which it may be subjected to.

This emission warranty is valid for 30,000 Kms / 3 years from the date of first sale whichever earlier, to the first customer and is in addition to and parallel to the warranty policy, conditions and obligations laid down in the Owner's Manual.

Royal Enfield further warrants that if on examination by its Royal Enfield Authorised Service Centre, the motorcycle fails to meet the specified emission standards, then the Authorised Service Centre shall take necessary corrective measures and shall, at its sole discretion, repair or replace free of charge components of the emission control system to meet the required emission standards.

The method/s of examination to determine the warranty conditions of the emission warranty related components will be at the sole discretion of Royal Enfield and / or our Authorised Service Centre and results of such examination will be final and binding. If on examination the warranty conditions of the part/s is/are not established, Royal Enfield will have the right to charge all, or part of the cost of such examination to the customer in addition to the cost of the components.

EMISSION WARRANTY

In case of acceptance of the component/s under Emission warranty, Royal Enfield will replace free of charge the component/s as required. However, the consumables like fuel, lubricants, solvents, etc shall be chargeable to the customer as per actuals.

In case any of the components covered under emission warranty or the associated parts are not independently replaceable. Royal Enfield will have the sole discretion to replace either the entire assembly or parts of the assembly through suitable repairs.

Royal Enfield reserves the right to carry out necessary consequential repairs to the motorcycle or replace any part, in addition to the repair or replacement of the components covered under emission warranty, to establish compliance to in-use emission standards. Such repairs / replacements will be chargeable to the customer.

All parts removed for replacement under warranty will become the property of Royal Enfield.

Royal Enfield will not be responsible for the cost of transportation of the motorcycle to the nearest Authorised Service Centre OR for any loss due to non availability of the motorcycle during the period of examination and repairs by Royal Enfield and / or their Authorised Service Centre.

EMISSION WARRANTY

Royal Enfield will not be responsible for any penalties that may be charged by statutory authorities on account of failure to comply with the in-use emission standards.

The cost incurred to check emission of the motorcycle will have to be borne by the customer.

Emission warranty will be applicable irrespective of the change of ownership of the motorcycle provided all the conditions as laid down in this document are met from the date of original sale of the motorcycle.

THE WARRANTY SHALL APPLY IF THE CUSTOMER

- Observes all the important instructions and any other precautions listed in the owner's manual.
- Under all circumstances uses lubricants and fuel as recommended by Royal Enfield.
- Regularly obtains and carries out maintenance in accordance with Royal Enfield guidelines and enters the details in the Log book.
- Immediately approaches the nearest RE Authorised Dealer / Service Centre upon discovery of failure to comply with the emission standard in spite of having maintained and used the motorcycle in accordance with the instructions in the owner's manual and having carried out such repairs and adjustments as may be required with a view to establish such compliance.

EMISSION WARRANTY

- Production of a valid Pollution Under Control Certificate is necessary to claim Emission Warranty.
- Produces the owner's manual and Log book for verification details.
- Produces receipts covering maintenance of the motorcycle is specified in the owner's manual from the date of original purchase of the motorcycle.
- Produces valid certificate of Insurance and R T O Registration Certificate (R.C. Book).

THE EMISSION WARRANTY SHALL NOT APPLY IF

- A valid "Pollution under control" certificate is not produced.
- The motorcycle is not serviced by RE Authorised Dealer / Service Centre as per the service schedule described in the maintenance chart.
- The motorcycle has been subjected to abnormal use, abuse, neglect and improper maintenance or has met with an accident.

EMISSION WARRANTY

- Replacement parts not specified and approved by Royal Enfield have been used.
- The motorcycle, or parts there of, has been altered, tampered with or modified or replaced in an unauthorised manner.
- The odometer is not functioning or the odometer and / or its reading has been changed / tampered with, so that the actual distance covered cannot be readily determined.
- The motorcycle has been used for competitions, races and rallies or for the purpose of establishing records.
- On examination by Royal Enfield or its Authorised Dealer / Service Centre, if the motorcycle shows that any of the conditions stipulated in the Owner's manual with regard to use and maintenance have been violated.
- The motorcycle has been run on adulterated / leaded fuel or lubricant other than those specified by Royal Enfield in the Owner's manual or any other document given to the customer at the time of sale of the motorcycle.
- The emission related components are tampered with.
- All service and parts related bills and vouchers incurred during the tenure of the emission warranty is not produced.
- All maintenance activities carried out on the motorcycle during the tenure of the emission warranty are not entered in the log book.

EMISSION WARRANTY

TIPS TO BE ON THE RIGHT SIDE OF LAW

- Always get your motorcycle checked to meet the emission regulations through an authorised emission checking centre.
- Always carry a valid "Pollution Under Control" certificate with you, as and if applicable by law.

TIPS TO REDUCE POLLUTION

- Ensure that the periodical maintenance is carried out as stipulated in the owner's manual through a Royal Enfield Authorised Service Centre.
- Use only Unleaded petrol (91 RON or higher) from reputed fuel pumps.
- Ensure the fuel used is not adulterated.
- Use correct spark plug as recommended in the owner's manual.
- Use lubricants as per recommendations given on grade / brand in the owner's manual.

EVAPORATIVE EMISSION CONTROL SYSTEM WARRANTY

The following warranty applies to the evaporative emission control system.

Royal Enfield Motors warrants the first owner and each subsequent owner, that this motorcycle is designed and built so as to conform, at the time of sale, with applicable regulations specified by the evaporative emission control system related parts fitted to this motorcycle are free from defects in materials and workmanship which may cause this motorcycle not to meet applicable regulations period of 24 Months from the date of first use of the motorcycle.

The Warranty period shall begin either on the date the motorcycle is delivered to the first retail purchaser OR from the first date the motorcycle is used as a demonstrator OR as a display and/or trial motorcycle.

THE FOLLOWING ARE NOT COVERED BY THE EVAPORATIVE EMISSION CONTROL SYSTEM WARRANTY

1. Failures which may arise as a result of misuse, alterations, accidents OR non performance of routine maintenance, as specified in the Owner's Manual.
2. Replacing, removing OR modifying any portion of the EVAPORATIVE EMISSION CONTROL SYSTEM (consisting of fuel tank, fuel tank cap, canister, purge valve, throttle body, vapor hoses, fuel hoses and hose connectors) with parts not certified by Royal Enfield.

EVAPORATIVE EMISSION CONTROL SYSTEM WARRANTY

3. Loss of time, inconvenience, loss of motorcycle use or any other consequential loss or damages.
4. Any motorcycle in which the Odometer has been tampered with OR the speedo cable has been disconnected for any reason OR is broken and not replaced immediately, due to which the exact distance covered cannot be determined.
5. Normal aging of parts such as fuel hoses, vapor hoses, gaskets and rubber components.

RECOMMENDATIONS FOR REQUIRED MAINTENANCE

It is recommended that the routine maintenance of the motorcycle be carried out at specified intervals and any maintenance to the evaporative emission control systems should be performed only by an Authorised Royal Enfield Service Centre and using only genuine Royal Enfield spare parts.

ENVIRONMENT CARE

BE AN ENVIRONMENTALLY CONSCIOUS RIDER

Swachh Bharat is Sachh Bharat. Being a Royal Enfield rider help the nation and the future generation for a cleaner environment

Engine oil, oil filter, petrol, Battery, tyres, tubes, electrical & electronic parts replaced on your vehicle are to be disposed off in a proper way without polluting the environment. When your vehicle is attended in a Royal Enfield workshop our dealers do take care of that aspect. If you are getting it attended elsewhere please ensure that items are segregated and kept in a suitable container or bag without allowing them to get into soil, water or sewerage line, drains, water bodies like lake, canal, river. Sea etc. We strongly recommend that they are disposed off, in accordance to the applicable law, through Pollution Control Board approved agencies in the locality.

ENVIRONMENT CARE

CLEANING OR WASHING YOUR ROYAL ENFIELD

Please ensure that the effluents are not discharged into the environment. Please promote dry washing which helps the nation to conserve water too.

This note does not constitute legal advice; please contact your local authorities or your nearest Royal Enfield Service Centre for further guidance.

FREE SERVICE COUPONS

Customer Copy

Free Service Coupon - 1 (Valid till 500 Kms / 45 days)			
Job Card No	:	Date	:
Km Reading	:	Dealer Code	:
Work done	:		
Dealer Stamp & Signature			

Dealer / ASP Copy

Free Service Coupon - 1 (Valid till 500 Kms / 45 days)			
Job Card No	:	Date	:
Km Reading	:	Dealer Code	:
Work done	:		
Dealer Stamp & Signature			

Customer Copy

Free Service Coupon - 2 (Valid till 5000 Kms / 6 months Whichever is earlier)			
Job Card No	:	Date	:
Km Reading	:	Dealer Code	:
Work done	:		
Dealer Stamp & Signature			

Dealer / ASP Copy

Free Service Coupon - 2 (Valid till 5000 Kms / 6 months Whichever is earlier)			
Job Card No	:	Date	:
Km Reading	:	Dealer Code	:
Work done	:		
Dealer Stamp & Signature			

FREE SERVICE COUPONS

Customer Copy			
Free Service Coupon - 3 (Valid till 10,000 Kms/12 months whichever is earlier)			
Job Card No	:	Date	:
Km Reading	:	Dealer Code	:
Work done	:		
Dealer Stamp & Signature			

Dealer / ASP Copy			
Free Service Coupon - 3 (Valid till 10,000 Kms / 12 months whichever is earlier)			
Job Card No	:	Date	:
Km Reading	:	Dealer Code	:
Work done	:		
Dealer Stamp & Signature			

Customer Copy			
Free Service Coupon - 4 (Valid till 15,000 Kms/18 months whichever is earlier)			
Job Card No	:	Date	:
Km Reading	:	Dealer Code	:
Work done	:		
Dealer Stamp & Signature			

Dealer / ASP Copy			
Free Service Coupon - 4 (Valid till 15,000 Kms / 18 months whichever is earlier)			
Job Card No	:	Date	:
Km Reading	:	Dealer Code	:
Work done	:		
Dealer Stamp & Signature			

SERVICE MAINTENANCE RECORD

S.No.	Date	Job Card No.	kms/ miles	Brief details of work / service	Royal Enfield Authorised Dealer
1.					
2.					
3.					
4.					
5.					
6.					
7.					
8.					

SERVICE MAINTENANCE RECORD

S.No.	Date	Job Card No.	kms/ miles	Brief details of work / service	Royal Enfield Authorised Dealer
9.					
10.					
11.					
12.					
13.					
14.					
15.					
16.					

REGIONAL & AREA OFFICES

R1 : Chandigarh, H.P, J&K, Punjab Royal Enfield SCO, No. 5, 1st Floor, Sector-11 , PANCHKULA (Haryana) Pin Code - 134 112. Tel: 0172-5011255, 5011251	R3 : Uttarkhand & Uttar Pradesh Royal Enfield UGF 15-19, Landmark Arcade, 2 Badshah Nagar Crossing, Faizabad Road, LUCKNOW – 226 006. Tel: 0522-6566675 Fax: 4005973	R6 : Orissa & West Bengal Royal Enfield Shrachi Tower, 3rd Floor, 686 Anandapur, KOLKATA - 700 707. Tel: 033-40060206 / 0209	R8 : Goa & Maharashtra Royal Enfield Plot No.16, Sector -1, Sion Panvel Highway, Nerul, NAVI MUMBAI - 400 706. Tel: 022-27700395, 27700501	R10 : Karnataka Royal Enfield Door No. 2067/1, 2068/2, East End "A" Main 9th Block, Jayanagar, BANGALORE - 560 069. Tel: 080-22440588, 41753277, 41536488
R2 : Delhi, Haryana, NCR & Rajasthan Royal Enfield C/o EICHER ENGG.COMPONENTS Plot No. 7, HSIDC Industrial Area, Sector 18, Palam Gurgaon Road, GURGAON (Haryana) - 122 015. Tel: 0124-4278138, 4278139 Fax: 4382148	R4 : Gujarat & Madhya Pradesh Royal Enfield 103, Safal Prelude, Opp. Parsavanath Esquire Cross Road, Corporate Road, Prahlad Nagar, Off. S.G. Highway, AHMEDABAD - 380 015. Tel: 098-25113168 Fax: 079-40024461	Royal Enfield A Unit of Eicher Motors Ltd. 407, 4th Floor, Nirmala Plaza, Forest Park, BHUBANESWAR - 751 009. Tel: 0674-6540206	Royal Enfield 203, 204 Sneha Ganga, Near Vega Centre, Shankar Seth Road, Swargate, PUNE - 411 037. Tel: 020-40028090 Fax: 24447174	R11 : Tamilnadu & Andaman Royal Enfield Plot No. 350 to 354, 2nd Floor, 4th Link Street, Nehru Nagar Industrial Area, Kottivakkam, (OMR-IT Highway), CHENNAI - 600 096. Tel:044-42070661, 24540828
Royal Enfield G-5, 6, 7, Gitanjali Towers, Ajmer Road, JAIPUR - 302 006. Tel: 0141-4106747, 4034748 Fax: 0141-4106748	R5 : Bihar, Chattisgarh & Jharkhand Royal Enfield 3rd Floor, Maple Plaza, Gate No. 2 , Ashok Nagar, RANCHI (Jharkhand) - 834 002. Tel : 0651-2245262	R7 : Arunachal Pradesh, Assam Manipur, Meghalaya, Mizoram, Nagaland & Tirupura Royal Enfield Astha Plaza, 4th Floor (M4-2), G S Road, Opposite Deorah College, Ulubari, GUWAHATI - 781 00 . Mob: +91 8135846461	R9 : A. P. & Telangana Royal Enfield (A Unit of Eicher Motors Ltd) No: 8-3-166/B to F, Erragadda Main Road, Beside Gokul Theatre, Erragadda, HYDERABAD - 500 018. Tel: 7093190003, 7416783025	R12 : Kerala & Lakshadweep Royal Enfield 25/85A, Opp. to IOC Pump, Koonamthai, Edappally Post, KOCHI - 682 024. Tel: 0484-6494990, 6494991 Fax: 2543616

AUTHORISED DEALERS

ANDHRA PRADESH	ANDHRA PRADESH	ANDHRA PRADESH	ANDHRA PRADESH	ANDHRA PRADESH
Amlapuram Shri Jayalakshmi Automobiles +91 9618349555, 8332912719	Chirala Lekhana Automotives +91 8885002114 8885002113	Guntur-Auto Nagar Jubilant Avenues Pvt.Ltd +91 8143008506; 8507	Kurnool Sandhya Automotives +91 9394253377, 9849542749, 08518-253377	Nellore Rishi Motors +91 8977713377, 9866162859, 8977714477
Anakapalli Singam Automobiles +91 9573790880; 9951332563	Chittoor Sri Sai Motors +91 9490094908 9100644415, 08572-245057	Guntur-Chandramauli Nagar Jubilant Avenues Pvt.Ltd +91 8143008508, 8341622655	Machlipattanam TAPASYA MOTORS +91 9866488811	Nellore-Inside City Rishi Motors +91 8977713377, 8977714477 +91 9866162859
Anantapur-Rudrampeta By-Pass Thump & Threads Automotives +91 9701651555	Eluru Classic Automotive +91 9652238585 08812-234582	Jangareddygudem Classic Automotive +91 8897045812	Madanpalle Sri Sai Motors +91 8121004555; 9100622208	Ongole Lekhana Automotives +91 8885002112 8885002113
Adoni-Yemmiganur road Sandhya Automotive +91 9849542749; 9394253377	Gudivada Tapasya Motors +91 9333342222	Kadappa Anjana Bikes +91 9247041555 9010389998	Nandyal Dheeru Motors +91 9133065553 +91 9133065554	Padmanabhapuram Village Lakshmi Automobiles +91 9640822666, 8008622666
Bhimavaram Varma Automotives +91 7095812666 +91 7095816888	Gudur Rishi Motors +91 8977727798	Kakinada Shri Jayalakshmi Automobiles +91 8332912719 0884-6443555	Narasaraopet Anu Auto Agencies +91 7893301444, 7893301555, 086472-21787	Prodattur Garisa Automotives +91 9494078666; 7661848444

AUTHORISED DEALERS

ANDHRA PRADESH Rajamahendravaram- Stadium Road Sri Ram Automobiles +91 9246665513	ANDHRA PRADESH Tenali Shakthi Motors +91 8886744494, 8644223555, 08644-223555	ANDHRA PRADESH Vijayawada- M G Road Mahalakshmi Motors +91 8886322559, 9581922559, 8886422559	ANDHRA PRADESH Vishakhapatnam - Tuni Sri Ram Automobiles +91 9966738924	ASSAM Barpeta G.S. Auto +91 8472987341
Rajahmundry Sriram Automobiles +91 9246665513 0883-2422117	Tirupathi Sri Sai Motors +91 9295091444 8572245057	Vijayawada- Ring Road Pravallika Motors +91 7842559555 0866-2586858	Vishakhapatnam-Gajuvaka KISHORE AGENCIES +91 9963223271	Bapujinagar. Opp -Bharat Petroleum Goalpara Riders INN +91 9706643717
Srikakulam Lakshmi Automobiles +91 9032929235 8121929235	Vijayawada- Beside Swarna Hotel Pravallika Motors +91 7842756555	Vishakhapatnam - Gajuwaka Cidanta Motors +91 9949334365, 0891-6562008, 6502008	Vizianagaram Lakshmi Ganapathi Automobiles +91 7382323344	Biswanath Sunmah Motors Pvt Ltd +91 9127069243
Tadipatri - Anantapur Dheeru Motors +91 7730077770	Vijayawada- Gollapudi Mahalakshmi Motors +91 9581922559	Vishakhapatnam - Nad Junction Saran Motors +91 8885947222 +91 8885847222	ARUNACHAL PRADESH Naharlagun - Itanagar Bucho Royal Enfield +91 9402689853 0360-2350103	Bokajan Eshan Motors +91 7896169021; 9988776655; 8974054011
Tanuku - Pydiparru Varma Automotives +91 8977779999; 8367781116	Vijayawada- Kanuru Pravallika Motors +91 7842559555 0866-2586858	Vishakhapatnam - Seethammadhara Royal Enfield Company Stores +91 8897353382 0891-2768887; 2768886	ASSAM Baihata Chariali-Kamrup S.S.Automobiles +91 9954034195	Bongaigaon Swastik Automobiles +91 7086030373; 7086030370

AUTHORISED DEALERS

ASSAM	ASSAM	ASSAM	ASSAM	BIHAR
Dibrugarh Rider's +91 8472913182, 7035757316 0373-2370018; 2370014	Guwahati-Opp. Akash Hyundai-P.O. Sawkuchi Saraighat Riders +91 7086035995	Nalbari Rouchand Automobile +91 9854532144	Tezpur G.M Associate +91 9707026331 9706471764, 03712-237777	Begusarai Mayamanu Motors Pvt. Ltd +91 7260851555
Dhubri Dynamic Motors +91 8724098018	Jorhat Achharsingh Royal +91 9864010145 +91 9207041076	North Lakhimpur Rishi Riders +91 9854100000, 9954391219	Tinsukia SD Royal +91 9957714273	Bettiah Mishra Automobiles +91 7280046825, 8877985073, 06254-246273
Duliajan-Kamalabari Road Free Ride Motors +91 9435030639	Kokrajhar GS Riders +91 9830701535	Silchar Bina Automobiles Pvt Ltd +91 9954008888 03842-225016	BIHAR Ambedkar Chatravas - Ward no 31, Police Line Brijraman Trading Pvt. Ltd. +91 9939433003	Bhagalpur Sri Ram Moto Corp +91 9472890189
Golaghat Singh's Ride +91 8472985025	Mangaldai-Bhebarghat Darrang Riders +91 7896152202	Sivasagar Funshine Getaways Pvt. Ltd. +91 9864020240	Araah Om Wheels +91 9471444405 06182-233338	Biharsharif PNN Automobiles +91 9334038042, 9709844666
Guwahati- Maligaon Chirag Enfield +91 9435400437, 7035125288	Nagaon Bajrang Motors +91 9127621892	Station Road Dhemaji, Ramnagar Sanjoy Enterprise +91 9954913764	Aurangabad Yodha Automobiles Pvt. Ltd +91 9934012273, 7283001751	Buxar-Near Kaali Mandir Shiv Prabha Automobiles +91 9430990977
Guwahati- G S road Shahila Expositions Pvt Ltd +91 9435549786, 9706077793, 0361-2335025	Nagaon Balaji Motor ++91 9435160785			Champa Neeraj Royal +91 7047511730 +91 8871704777

AUTHORISED DEALERS

BIHAR Chapra Supriyam Automobiles + 91 9534677444, 9128739999, 06152-242999	BIHAR Gopalganj Riders cafe +91 9199547786, 9060524444; 9060684444	BIHAR Madhepura, Narsingh Complex Chandra Darbaar Motors Pvt. Ltd +91 9971000243	BIHAR Muzaffarpur- Manikpur Gautam Motors - UNIT - 2 +91 9931475305	BIHAR Patna-Saguna More Siddhi Vinayak Automobiles +91 8092981877, 8406002596, 0612-212948
Darbhanga SYV Motors +91 8227887777 06272-242777	Hajipur Ambika Bhawani Automobiles +91 9835641123 06224-295280	Madhubani Shagun Auto Sales +91 9431486654 06276-228014	Muzaffarpur-Sitamahari Road Kumar Automobiles +91 7283000388; 7283000387	Patna-Zero Mile Sukhmani Motors Pvt. Ltd. +91 9709761441 0612-3297056
DARBHANGA-MAHANT NAGAR Surya Automobile +91 9472077777	Katihar Jaiguru Motors Pvt Ltd +91 9430909966 06452-290172	Mohania - Dist Kaimur Swastika Motors +91 9431067771	Nawada-Kendua - Nawada Bazar Road R.N. Automobiles +91 9771499530	Purnea Link Motors +91 7766917026
Forbesganj Yashraj Motors +91 9472177378	Kidar-Mahant Nagar Katihar Jaiguru Motors Pvt Ltd +91 7280054000	Motihari Raj Motors +91 9472582848 9818033809, 06252-230373	Patna-Boring Road Ambey Motors +91 7541820021	Puraniganj - Munger Vidya Automobiles +91 9570177773
Gaya Kusum Motors +91 8271020543 0631-2210105	Kishanganj S.B Motors +91 8409966441	Muzaffarpur- Maripur Gautam Motors +91 7091592901; 7091592902, 0621-2220056	Patna-Near Birla School Kankarbagh Ananta Shree Enterprises Pvt Ltd +91 8651383040	Raxaul Ace Motors +91 7992268617
				Saharsa 7 Hills Automobiles +91 8877080661 06478-227007

AUTHORISED DEALERS

BIHAR	CHANDIGARH	CHATTISGARH	CHATTISGARH	CHATTISGARH
Samastipur Aditya Motors +91 8406803308 5452264047	Chandigarh - Sector 32 D Garg Autos +91 9915596388, 0172-2665246	Bhilai AAN Automotive +91 7886996000 0788-4040512	Narsinghpur- Itwara Bazaar Kandeli Kailash Motors +91 9611903853	Raipur-Lodhi Para Chowk Indian Motors +91 7714221500 0771-4221500; 4221400
Sasaram Vintage Auto Corp +91 8540948771 +91 9304503020	Industrial Area, Mohali Manchanda Autos +91 9988994000	Bilaspur Blue Sapphire Motors +91 8982407770 07752-407770	Neemuch Galaxy Motors +91 9229258110	Raipur- Tatibandh 6th Gear +91 8109309666 0771-4070666
Siwan Sri R.L. Automobile Pvt. Ltd. +91 7482063886, 7482069386, 06154-247686	New Motor Market, Manimajra Kamal Motors +91 9814334713	Dhamtari Shri Ram Automobiles +91 9179995522	Raigarh Priyanka motors +91 7389910800 07762-233550	Rajnandgaon Shubh Auto +91 9424102224 07744-401491
Sitamarhi Nili Automobiles +91 7283007813, 7631313834	Retail Outlet - SCO-58 Chandigarh Manchanda Autos +91 9915047010	Jagdalpur Kambo Motors +91 7692850003	Raipur Basant Motors +91 8959888888	Champa Neeraj Royal +91 7047511730
CHANDIGARH Chandigarh - Sector 27 C Manmohan Auto Stores +91 9216227366, 0172-5071351	CHATTISGARH Ambikapur Dev Automobiles +91 9753117804 07774-222804	Korba Kailash Auto Agency +91 9826109907 07759-245482	Raipur- Gaurav Path - Panchsheel Nagar Aadityaraj Automobiles +91 7697208337 0771-4030550	

AUTHORISED DEALERS

GOA	GOA	GUJARAT	GUJARAT	GUJARAT
Bardez, Survey No 263/9-Goa Royal Enfield Garage Cafe Goa +91 9833418672	PONDA Saini Motors +91 9823186099	Ahmedabad-Nehru Nagar Sarabhai Motors +91 9737725550, 079 26635105	Bhavnagar Gujarat Auto Centre +91 8734936206 0278-2512648	Gandhidham N.P. Auto Agencies +91 9426140290; 9723540290, 02836-295927
Bhiwandi - Thane S.R. Motors +91 8291064222	GUJARAT Ahmedabad- Akashat Complex Basement Karnavati Bikes Pvt Ltd. +91 9825061120	Ahmedabad- Nehru Nagar Sarabhai Prowheels +91 9081800299	Bhestan-Bhagvati Nagar Ind. Estate Tulsi Enterprise +91 9879393300	Gandhinagar Aanal Auto Agency +91 9099049555; 8980001123 02712-23262020
Goa - Margaon Saini Motors +91 7767006138, 8308838197 0832-2740343; 2740345	Ahmedabad-Mani Nagar Sarabhai Automotives +91 9737721166, 9737728833 079-25891030; 3010	Anand Royal Ridentity Pvt Ltd. +91 9724154004 02692-644352	Bhuj PM Autolink +91 9825900279; 9925635279, 02832-231279	Godhra Concord Auto +91 9879074373 02672-265522
Goa - Margaon Speedo Resources +91 8390118814	Ahmedabad- Naroda Krishna Wheels +91 9925333446 079-29704155; 29703055	Bardoli PSG Motors +91 9924755549, 9824175164	Botad Old Soul Motorcycles +91 9737000013	Happa New Chandra Motor Cycle Agency +91 7984825429; 9824211699, 0288-2552888; 2678024 ;2550863
Goa-Mapusa Shauna Auto Agencies +91 8326520712	Ahmedabad- Narangpura Karnavati Bikes Pvt. Ltd. +91 9099031295; 9099031296, 079-27490068	Bharuch Vraj Auto +91 9157232857, 9904450005, 02642-225757	Dharampur Char Raasta-Swastik Arcade Veer Autonity +91 9099965274	HimmatNagar Rajvee Auto +91 9909990405
Goa - Panaji Auto Guides +91 9326102087 9168611669, 0832-2225865				

AUTHORISED DEALERS

GUJARAT Jamnagar New Chandra Motor Cycle House +91 9824211699	GUJARAT Morbi Dev auto +91 9054265550; 65551; 65552 +91 9054265553; 65554	GUJARAT Rajkot - Gondal Road Aditya Moto Gujarat Pvt. Ltd. +91 9099092580, 0281 2371070	GUJARAT Surendranagar Old Soul Motorcycles +91 9909008000 9737000013, 02752-242777	GUJARAT Surat Munjani Motors +91 7436000300
Junagadh Shree Aashapura Enterprise +91 8460242191 0285 2660111	Navsari PSG Motors +91 9924755521 02637-265559	Rajkot - Mota Mava Kalawad Road Dev Motors +91 8401799993 0281-6458888; 9157877331	Vadodara- Harni road Amba Motors +91 7820010060 0265-2463232	Vyara PSG Motors +91 9824175164
Mehsana Parklane Auto +91 9925014803 9925003091, 9925004538	Palanpur Parklane Auto +91 9925001944	Surat-Adajan Hajira Main - Adajan JSN Motors +91 8401600411 0261-2840023	Vadodara - Old Padra Road RSA Automotives +91 9574257999; 9574256999, 2652355040	HARYANA Ambala - Ambala Chandigarh Highway Royal Motors +91 9468476100
Mirzapur Shreeji Auto Traders +91 9375004192	Palki-Nr.Hanumant Hospital Indian Motors +91 8401602648	Surat - Sarthana Varacha Purav Automobiles +91 9979841546, 9979841547	Vapi Royal Thumpers +91 9726818181; 9879565274	Ambala cantt- Rai Market Royal Motors +91 9541925454; 9315100442 0171-2630795; 2631495
Modasa Rajvee Motors +91 9909990405	Porbandar Kailash Motors +91 8000099990		Veraval Anjaney Motors +91 9512779995	Baldev Nagar- Ambala Royal Motors +91 9468476100

AUTHORISED DEALERS

HARYANA	HARYANA	HARYANA	HARYANA	HIMACHAL PRADESH
Bhiwani Sheoran Auto +91 8950291600 01664-252216	Jhajjar JMD Automobiles +91 8199885570 8199885568	Narnaul Royal Jindal Auto Pvt Ltd +91 8901451000, 8053939792	Rohtak Badhwar & Co. +91 8059880031 01262-242034; 241173	Baddi Simran Automobiles +91 9816167884
Fatehabad SDB Automobiles +91 9728942226 9254400077, 01667-221786	Kaithal Road- Cheeka Raghav Automobiles +91 8199947003; 7357324006; 8199946000, 8199947002	Palwal Kartike Motors +91 9813131455 01275-240454	Sirsa Gulzar Motor Agencies +91 9996147200 01666-221367; 230459	Chamba Champavati Autos +91 9736678651 01899-226747
Gohana Heydaan Motors +91 9034444433	Karnal Monga Motors +91 9354140008 184-2261810; 2272729	Panipat Monga Automobiles +91 9354140006 0180-4000393	Sonipat Heydaan Motors +91 9728900200, 9034444433, 0130-2233004	Dharamshala Him Enfield +91 7894389090 8894389090
Hissar Malik Automobiles +91 8572888890 01662-276103	Kurukshetra Charkhi Dadri Motors +91 9548282000	Pehowa Nexgen Motorcycling +91 9254022292; 9254022257	Tohana SDB Automobiles +91 9728942229; 9254400077	Hamirpur (ASP) Parkash Royal Enfield +91 9816058483 01972-258483
Jind Gill Automobiles +91 9416476459, 7027002580	Kurukshetra Nexgen Motorcycling +91 9254022257	Rewari Premium Automation Pvt Ltd +91 8607482200, 8607466600, 01274-251000	Yamuna Nagar Falcon Automobiles +91 9315431300; 8950462224, 9812990694	Kangra Snowline Autos +91 9816075428

AUTHORISED DEALERS

HIMACHAL PRADESH	HIMACHAL PRADESH	JAMMU & KASHMIR	JAMMU & KASHMIR	JAMMU & KASHMIR
Lahaul & Spiti Grease Moto Club +91 7649944889	Solan Tapan Industries +91 7807400172 01860-1800072	Jammu Durga Associates +91 9697500020 7780909719	Prem Nagar Newplot-Jammu Yahoo Technocrats +91 9419191241	Vijaypur Lovish Motor +91 8492005757
Manali Heaven On Earth Automobiles +91 9459300881 01902-205032; 251151 08350854002 (Kullu)	UNA Sharma Automobiles +91 9318536733 9318536755, 09218-446755	Jammu Xtream Motors +91 7006340294; 7006994608, 9797568876	Srinagar Cafe Bike Inn +91 9797470011	JHARKHAND
Mandi Shivam Automobiles +91 9805473700 01905-243077 9736700777	JAMMU & KASHMIR	Leh(ASP) Venture Third Pole +91 9419177466	Srinagar PCS Automobiles +91 9797460011 0194-2472781	Bokaro - City Center G.R.Motors +91 9934109008, 8092343678, 6542265452
Paonta Sahib -Sirmour R.S.Enterprises +91 9418117089 01704-223687	Baramula ZMR Automobiles +91 9906727248	Kathua Lovish Automobiles +91 9419166881, 9070855555 01922-235010	Digiana camp (ASP) Sumeet Motors +91 9419236396 0191-2431058	Bokaro-ITI MORE, CHAS G.R.Motors +91 8092343678
Shimla Tapan Industries +91 7807500272 01792-227990	Doda R.A.Enfield Unit - II +91 9622118829	National Highway - 1 A Batengoo Anantnag, J & K Mountbird Wheels +91 9596769706	Udhampur R A Enfield +91 9055505002 01992-250008	Daltonganj Arjun Automobiles +91 9006082822 +91 8235121935
	Jammu - Janipur road Reliance Motors +91 9419191241 0191-2536084, 2575251			Deoghar Roy Brothers +91 9431157591 06432-240371

AUTHORISED DEALERS

JHARKHAND	JHARKHAND	JHARKHAND	KARNATAKA	KARNATAKA
Dhanbad Arti Automobiles +91 9470133444 +91 9031084005	Jamshedpur - Bajrang Nagar NH 33 Cruiser India +91 9204004142	Ranchi - Harmu Road Raghuram Autocare +91 9905110006 0651-6571607	Bangalore Bommasandra Motors (Unit of Electronic City Motors) +91 8496957777; 8970392555	Bangalore-Bellary Road CVS Motors +91 7406332266
Dumka Majestic Autobikes Pvt Ltd. +91 9798777007	Jamshedpur - East Singhbhum NDG Motors Pvt Ltd 6200454649	Ranchi - Kokar Sri Nivas Automobiles +91 9771420322 0651-2542789	Bangalore-Kpura Road H.S.R. Services +91 7829000350; 9980762849	Bangalore - BTM 2nd stage - Service Royal Enfield Company Store +91 9673596344; 9343555583, 080-40905108/ 26689975/41229111
Giridih Shree Sanmati Enterprises +91 9234645555; 9534140200	K.G. Asharam-Dhanbad Thunder Motors Private Limited +91 8210257767	Ranchi-Near Hill tank, West Circle Marvel Autobikes +91 7543886112	Bangalore-Banaswadi CVS Motors +91 9739030309	Bangalore-Electronic City Electronic City Motors +91 7026613071 to 79 & 80 8494942929
Godda Kaushalya Motors +91 9801196972	KODERMA - NEAR HANUMAN MANDIR Vinayak Bikes +91 8092372003	Ranchi - Sainik Bazaar New Auto Centre +91 9204857156	Bangalore-Bannerghatta Royal Enfield Company Store +91 9673596344; 9986736472, 080-40905108, 26689975, 41229111	Bangalore - Hoskote Main Road, Opp Commertical Tax Office Teknik + 91 9686999888
Hazaribag Riders Point +91 9234343422 +91 9031005518	Ramgarh Anjaney Automobiles Pvt. Ltd. +91 9431146297 +91 9031000430	KARNATAKA Bagalkot Bagalkot Motors +91 8884128877; 9916361134; 8197567124		

AUTHORISED DEALERS

KARNATAKA Bangalore-Indira Nagar Teknik Motors +91 9686999888; 8904006004 080-25284788, 40910005	KARNATAKA Bangalore - Raja Rajeshwari Nagar Accelerate Motors +91 7022049625; 7829900236, 080-28606969, 28608989	KARNATAKA Bangalore-Sudhamanagar H S R Services SDN +91 9343735655 080-22133119	KARNATAKA Bangalore - Yelahanka Acclaim Motors Pvt Ltd +91 9632881188; 9632881133, 9663550055	KARNATAKA Bellary Sanjeevini Automobiles +91 9591107601; 735377768, 08392-261027
Bangalore - Kengeri Accelerate Motors +91 7022049627	Bangalore-Magdi road H.S.R. Enterprises +91 9844067555; 9738000350, 080-23156617	Bangalore-Banasankari H S R Services- RAJ +91 9739000350; 9738000350	Bangalore (ASP) Sri Manjunatha Bullet Garage +91 9341220151, 9379555592, 080-25427066	Bidar Bhavani Motors +91 9019142142; 9379799992
Bangalore-Nagarbhavi S.R. Motors +91 9071340000, 080 3232 3333, 080 3232 4444	Bangalore -Dr. Rajkumar Road, Rajajinagar H.S.R. Enterprises +91 9066032350	Bangalore-Sadaramangala Village Whitefield Motors +91 9980995708 7349770028	Bhatkal Brahmi Motors +91 9743637456, 9620439161 08385-226836	Bijapur Rohan Motors +91 9986168363
Bangalore - Nelamangala Sri Sai Sadguru Motors +91 9071766021; 9071766025	Bangalore-Sarjapur Teknik Motorcycles +91 8904004004; 8904000300- 8904000700 080-40910003; 0004; 005	Bangalore - B Narayanpur Sai Ram Autocraft +91 9900029871, 080-64909090	Belgavi Shri Munishwar Motors Pvt. Ltd. +91 9845023535; 9620379458	Coorg Near Sayaji Rao Road Abhyuday motors +91 9538841412; 8212494824
Bangalore- Peenya Sri Sadguru Sai Motors 91 8151899998; 9886666302 080-28393666			Belgaum Shri Munishwar Motors Pvt. Ltd. +91 9916313244	Chikkamangalore Chickamagaluru Motors +91 9742289955

AUTHORISED DEALERS

KARNATAKA Chitradurga Jilu Bikes +91 9845127397 +91 8494900552	KARNATAKA Hassan Shree Subrahmanya Motors +91 9980751155, 9742217171	KARNATAKA Kolar Jagadamba Automobiles +91 9972522111; 8152226619	KARNATAKA Mysore-Vijayanagar 1st Stage Aadith Motors +91 7899912362; 7899912363 8214244467	KARNATAKA Outter Guruprasad Commercial Complex Frontline Automobiles +91 9686137888, 8197685999
Davangere Royal Automobiles +91 9844053511 08192-256239	Hubli - Airport Road Salimath Engineers Services +91 7259037590; 9480296644, 0836-3241160	Mandya Ruby Maratt Motorcycles +91 9591503399, 9148451759	Mysore (ASP) Kempananj. Agrahara Sri Venkateshwara Automobiles 0821-2427533	Raichur Chukki Motors +91 8792113336, 9663338489
Gadag Bagalkot Motors +91 8747064595	Hubli - Kusugal Road - Keshwapur Klasik Motors +91 8904800948; 8050601007, 0836-2288223	Mangalore eyyadi Indust. Estate Airport Road Frontline Automobiles +91 8861006478, 9900856033, 0824-4267573	Mysore (ASP) Kuvempu Nagar Abhyudhay Motor Services Pvt. Ltd. +91 9743721955; 9538841415, 0821-2462066, 2462067	Next to RBL Bank, Uttara Layout- Ramnagar Ramnagar Motors +91 9902065933; 9663338489
Gadag Gadag Motors +91 8147776496; 9513001495	Hunsur Aadith motors 08222-252395; 96, 7899000381	Mangalore-Vishal Arcade Building Veenu Motors +91 9108487051	Mysore - New Sayyajirao Road Abhyudhay Motor Services Pvt. Ltd. +91 8212494824; 9538841412	Shimoga Apollo Enterprises +91 9008138662; 9141187404, +91 41187404
Gulbarga Mukunda Wheels Pvt. Ltd. +91 9945249302; 9686001584, 08472-225302	Karwar Karwar Motors +91 7625078394	Mudhol Mudhol Motors +91 8197567124, 8884300000		Sirsi Sri Maruthi Auto Motors +91 9108484665 9148971805, 08384-226777

AUTHORISED DEALERS

KARNATAKA	KARNATAKA	KERALA	KERALA	KERALA
Sindhanur Chukki Motors +91 8792113336;	Bangalore - Hebbala CVS Motors +91 9739030309; 9986766660	Calicut-Francis Road Blue Mountain Autos +91 9895201667 0495-2302530	Cochin - Angamali, Areekal Junction Sanjo Motors +91 9809709999, 8943744444, 0484-6888889	Ernakulam St. Mary's Motors +91 7025213324
Tumkur Bhagavati Motors +91 9742273566; 9916826666	Bangalore - Sankey Road CVS Motors +91 7406999010	Calicut-Kunnamangalam Blue Mountain Autos +91 7510999990	Cochin - Chittoor Road St. Mary's Motors +91 8891000691; 9526028787, 0484-4022819	Aikkaraparambil House-Cochin JR & Sons +91 9567074013
Udupi Brahmi Motors +91 9164889161; 9164209161 0820-2527590	KERALA Adoor Yamuna Agencies +91 9747410243 0473-4229222	Calicut - Mankavu Luha Automotives +91 7025105333 0495-2333533	Cochin - Edapally Royal Enfield Company Store +91 7025233912 0484 - 6494991; 6494992	Kannur SS Motors +91 9567862458; 9567863980, 0497-2731312
Bangalore - Koramangala Koramangala Motors +91 7026603623; 8970872555	Alleppey Rider's Motors +91 9447265955	Calicut - Puthiyagandi SS Motors +91 9567863979 0495-2392200; 2390770	Cochin - Vyttila Kaizen Motors +91 7559800072 0484-2307072; 4047072	Kannur Vibrant Automotive +91 8111990066, 8111990022, 0497-2776660
Sanjeevini- Hospet Sanjeevini Automobiles +91 7996955595; 7353777768, 9886237276	Aluva- Thaikattukara Marikar Motors +91 9605932999 0484-2630222	Changuvetty-Kottakkal Barak Enterprises LLP +91 9847266699	EDAPPAL Mass Wheels Pvt. Ltd. +91 9387111333	Taliparamba-Chiravakku Near National Highway Vibrant Automotive TPBA +91 8111990084

AUTHORISED DEALERS

KERALA Kanhagad-GVHSS Road-south junction South West Motorcorp India Pvt Ltd +91 7594090909	KERALA Kollam - Bishop Jerome Nagar Marikar (Motors) Ltd. +91 9947031120; 1121; 8590988446, 0474-2732474	KERALA Kottayam Javeens Motoring Pvt Ltd +91 9446397300; 9446397500, 0481-2563455; 2567070	KERALA Palakkad PVR Wheels +91 9585259135	KERALA Perumbavoor Sanjo Motors +91 8592009991, 8943744444, 0484-6888885
Kasargod South West Motorcorp India Pvt Ltd +91 8527220499	Kollam- Kottappuram Unnoony Motors +91 9567671520	KOYILANDY KMS Automotives +91 9995997996	Pattanakkadu-Near KSEB Section Office Ramanattu Motor Corp +91 8138065555	Thalassery-Jubilee road Sharpline Automotive LLP +91 9446048668
Kayamkulam-Edasseril Junction Roverz Motors +91 9072546555; 9072584046; 9995006620	Kollam - Madanada Unnoony Motors +91 9567395208, 9995086444 0474-2764566; 2764567	Kuriachira-Chiyyaram village Tags Bikez +91 7012425850	Pathanamthitta Marikar Motors Ltd. +91 8111871222; 9388077007 9947031170, 0468-2223412	Thrissur-Karunanakaran Nambiar road Marikar (Motors) Ltd +91 8606863336; 9947031187 0487-2339307
Kayamkulam-Edasseril Junction Roverz Motors - MV	Kodungallur Pinnacle Motor Works Pvt Ltd +91 9072575721, 9072575722	Mundur-Opp Indian Oil Petrol Station Pinnacle Motor Works Pvt Ltd +91 7025600600	Pattambi-Palakkad Intrepid Works +91 9744072921 8606933015, 0466-2970666	Thrissur-Puzhakkal Padam Pinnacle Motor Works Pvt. Ltd. +91 7025600600; 8111994007 0487- 2385255
Akathiyoor-Kunnamkulam Motorad Works +91 7510411220	Kottarakara Unnoony Motors +91 9895562454	Palakkad Intrepid Works +91 8606933008, 8606933015,0491-2572331	Perinthalmanna ABC Motors +91 9447158400, 9988776655; 7591977700 04933-226677	Thiruvalla St. Mary's Motors +91 9526260400; 9847940600, 0469-2733243

AUTHORISED DEALERS

KERALA Thodupuzha Veliyathu Motors 91 8943200090 4862227899	KERALA Trivandrum - Kaimanam Junction Sivaji Motors +91 7736207777; 7736066716 7736107777, 0471-6506777	KERALA Fayaz Tower Tb Junction - KazhaKuttam Concept Bikes ATT +91 9048990850	KERALA KALPETTA TEMPEST Automotive +91 9567599299	MADHYA PRADESH Chattarpur Classic Wheelz +91 9644705705
Kattappana- Kottayam Road Veliyathu Motors +91 8086097788; 8086094444	Neyyattinkara Sivaji Motors +91 9884424128	Pappala- Kilimanoor, Concept Bikes KLMR +91 9048990532	WAYANAD TEMPEST Automotive +91 9447363762; 8590663131	Chattisgarh Nagorao Auto Engineering Works Pvt Ltd +91 9827400369
Muvattupuzha- Vazhappally Veliyathu Motors +91 8086094444	Trivandrum - M G road Marikar (Motors) Ltd +91 8606068466, 9526593337, 0471-2334621	Vadakara Grace Motors +91 7034775555, 7034774444	MADHYA PRADESH Betul-Kalapatha, Near Hanuman Mandir Shree Sai Automobiles +91 8878033981	Chhindwara Rahul Royal Motors +91 8889999602 07162-245255
Tirur ABC Motors +91 9605827000 9447029100, 0494-2422277	Trivandrum - Nedumangad Concept Bikes +91 9048990150	Nadapuram Grace Motors +91 7034552266	Bhopal - Hamidia Road Choudhari Tractor Agency +91 7869209584; 9425027691, 0755-5240614; 2735762	Dewas R R Motorcycles +91 8109103622 8269270709
Trivandrum-Attingal Concept Bikes +91 9048990256; 9745009966	Trivandrum - Vetturoad - Kazha kuttam Concept Bikes +91 9048400200; 9048990546	Valluvbaram- Malappuram ABC Motors +91 7034166300 0483-2770700	Bhopal-Padmanabh Nagar Ananya Auto +91 7389930806 0755-4076937	Guna Standard Motors +91 8823800085

AUTHORISED DEALERS

MADHYA PRADESH Indore - Nehru Market Krishna Motor Agency +91 7314237509, 0731-4237509	MADHYA PRADESH Jhabua- Indore Road Galaxy Motors +91 9229258110	MADHYA PRADESH Raipur Manoraj Automotive & Warehousing Pvt. Ltd. +91 9425207977	MADHYA PRADESH Ujjain Avis Auto +91 9424025067 0734-2520007	MADHYA PRADESH Sagar Road ASHISH MOTORS +91 9893110279
Indore - Sayaji Club Road RR Automotive +91 98266125432	Katni Royal Thumpers A Division of Superior Automobiles Pvt Ltd. +91 8962010075 07622-226474 ESH	Ratlam-Mitra Niwas Road Galaxy Motors +91 8889997394; 9229258110	Vidisha Adventure Bike +91 9425148606 0759-2408222	Gwalior Somya Motors Pvt. Ltd +91 8823800085; 7773000127
Indore-Annapurna Road JAGDISH MOTORS +91 8989898997	Khandwa Binwani Motors +91 9425909302 7332244222	Satna Manish Motors +91 8982171457 07672-251608	Itarsi Jaggi and sons Super Automotive LLP +91 9827673777, 07572-230230	MAHARASHTRA
Jabalpur Royal Thumpers +91 8962010072 0761-4042424; 4042423	Khargone-BISTAN ROAD PRABHU MOTORS +91 7240848484	Sehore-Sekdakhedi Choudhari Tractor Agencies +91 9425027691	Dhar Aaryashree Motors +91 9926396399	Ahmednagar Newaskar Automobiles +91 8087500900 0241-2470125
Jabalpur Royal Thumpers Unit II (A Division of Superior Automobiles Pvt Ltd) +91 9039010070	Indore - Chooti Gwaltoli AVS CORPORATION +91 9977007711	Shahdol Gupta Automotive +91 8718811703 0765-2231967	Sagar Royal Cruisers Pvt Ltd +91 8225003194, 07582-403003	Akola Agrawal Motors +91 8408089944 0724-2258259
	Jabalpur Varun Motorcorp India LLP +91 9039055590			Alibagh SK Autoriders +91 9970041579 02141-223030

AUTHORISED DEALERS

MAHARASHTRA Amravati Bhans Automotive +91 7620177060 0721-2510636	MAHARASHTRA Buldhana Samyak Automotive +91 9422181159, 9922900038, 072-62241273	MAHARASHTRA Chaula Jay Motors +91 9922880888	MAHARASHTRA Gondia Ved Automobiles +91 9326916819	MAHARASHTRA Karad Nand Enterprises +91 7030963218 02164-242772
Aurangabad - Bansilal Nagar S.K.Y.S Automobile +91 9028059252 0240-2350652	Boisar Sonith Motors +91 8291101575	Chiplun-Karad Chiplun Highway A K Autoriders +91 9028836793	Ichalkaranji Motor India +91 9822551777	Kolhapur Motor India +91 7841921923; 9822551777, 9822022170
Aurangabad-CIDCO-Cannaught Cherry Corporation +91 7720092857 0240-6601613	Borivali Unison Automobiles +91 7506555039 22265614014	MIDC Mirjole Ratnagiri A K Autoriders +91 9822133300	Indapur Sahyadri Auto +91 7387111109 02111-224111	Kolhapur M.R Patel & Sons +91 9970176761
Baramati Jay Motors +91 9960247655; 02112-221055	Ayodhya Nagar, Bhusawal Usha Motors Bhusawal +91 8888888831	Dhule Surbhi Motors +91 9371057573 02562-239933	Jalgaon Usha Motors +91 7768009996 7768009992, 0257-6999000	Latur Prisha Motors +91 9049607711 02382-200711
Beed- Jalna road Vtwin Motorsports (OPC) Pvt Ltd +91 7020061414	Chandrapur Dinesh Motors +91 8550991151 07172-260555	Gadchiroli Dinesh Motors +91 7755979733	Jalna Madhu Motors +91 7249638764	Malegaon Shaurya Motors +91 8380038156; 9527002881 02554-231171
		Gadginglaj Yashashri Motors +91 9657009444 9527094848	Kudal-Near Varadeshwar Mandir Swastik Motors +91 9673875552	

AUTHORISED DEALERS

MAHARASHTRA	MAHARASHTRA	MAHARASHTRA	MAHARASHTRA	MAHARASHTRA
Mumbai - Bhandup Soniya Motors Pvt. Ltd +91 9322314555 7208005215 022-65650153	Mumbai - Kandivali Voyage Motors +91 9146871013; 7498567890; 8424050855, 022-28087882	Mumbai- Kurla W Synergy Auto Inc. Phoenix +91 7506555039; 8652665522	Mumbai - Thane (Mira road) Unison Automobiles +91 7506555039 022-28456620	Mumbai - Thane (Ulhas Nagar) S R Motors (A Unit of Riya Motors Pvt. Ltd) +91 7506044995 0251-2700043
Amar Marg Amar Nagar Chembur- Mumbai Motokraft Automobiles +91 9819791510	Mumbai - Pratab Nagar Vikroli Road Voyage Motors +91 7039024054; 7498567890	Mumbai - Opp.Bandra Hindu Association Bandra (West) Company Store +91 9323015335; 9833015330	Mumbai - Thane - Belapur Road, Soniya Motors Pvt. Ltd +91 8291842106	Mumbai Nerul Ram Motorcycles +91 9323025335 022-27700394; 022-27700396
Mumbai - Andheri, Talati Apartments Irla Bridge Ishna Wheels +91 8879733417	Mumbai-Panvel Pratik Motors +91 9029422942 022-27480040	Mumbai-Thane (Dombivali) Pooja Motors +91 8425840752 9833890507, 0251-2470611	Shivram seth Amrutwar Road-Mumbai First Mumbai Store LLP +91 9152007372	Mumbai - Nerul Ram Motorcycles +91 9323025335
Mumbai - Goregaon Ishna Wheels +91 8879330226; 9819549111, 022-28711242; 28711243	Mumbai - Sakinaka Synergy Auto Inc +91 8286046565 022-28590085; 28590086	Mumbai - Thane (Godbunder) Soniya Motors Pvt. Ltd +91 9322315111, 7208005217, 022-25893202;	Mumbai - Thane (Vasai) SP Wheels +91 8446011105, 7420026685 0250-6511107; 6511108	Mumbai - Nerul Company Showroom Navi Mumbai +91 8888877777
			Mumbai - Virar SP Wheels +81 8454988666	

AUTHORISED DEALERS

MAHARASHTRA Mumbai-Opp. Kurla East Signal Malik Service Point +91 9892894789	MAHARASHTRA Nagpur - Opp to Mata mandir; Nalwadi Shri Krishna Automobiles +91 9769169180	MAHARASHTRA Nasik - Ganjamal Ostwal Autos +91 9595301414, 8805604949, 0253-2500291	MAHARASHTRA Phaltan Adved Motors +91 9822414061, 9822116321	MAHARASHTRA Pune - Fathima Nagar Platiinum Auto +91 7755932578; 2579 +91 9881171717
Mumbai-Mahim West P.R. Enterprises +91 9323015335	Nagpur - Near Toll Plaza Gondkhairri,Ta. Kalmeshwar Shri Krishna Automobiles +91 9823038694	Nasik - Satpur Moharir Auto Pvt. Ltd. +91 8378998294; 8378998295 0253-6630000	Pimgalgaon Shaurya Motors Shaurya Motors +91 9130068287, 9527002881, 02550-660604	Pune - Hadapsar Platiinum Auto +91 7030911278; 7030911284
Nagpur - Kamptee Road Ved Motors +91 7030907021 0712-2652222; 2654444	Nandurbar Dinesh Wheels +91 9673298999 +91 9764567877	Osmanabad Hatlai Auto +91 9822838888; 9763138888, 02472-228588	Pune - Adarsh Nagar Dhone Automobiles +91 7028922644 020-24273335	Pune - Kasarwadi Dhone Automobiles +91 7028045684
Nagpur - Sitaburdi Paragon Traders +91 9595622261 0712-2523456	Narayangaon Kings Royal Riders +91 9075009831 0213-2245542	Parbhani Chandrallama Automotive +91 9665516193, 9763300022, 2452-242299	Pune - Baner Kings Auto Riders +91 9146054611 020-27200202; 27200201	Pune - Khed Shivpur Siddh Auto +91 9673156622
Nagpur-Wardhaman Nagar Shri Krishna Automobiles +91 9372121346; 9970551171; 8237765439 0712-3191202	Nasik - Dwarka Ostwal Autos +91 7720099945 0253-2592717	Parli Shiva Motors +91 9765924477 02446-227477	Pune - Chinchwad Hridaan Motors +91 9422011110, 2069100202	Pune - Kothrud Siddh Auto +91 9168376611, 9673156622 020-25280050; 25280051

AUTHORISED DEALERS

MAHARASHTRA	MAHARASHTRA	MAHARASHTRA	MAHARASHTRA	MAHARASHTRA
Pune - Yerwada Dhone Automobiles +91 7028978074 020-60121812	Pune Sadguru Service Station +91 8308048854; 9011078854, 020-24350727	Satara Nand Enterprises +91 9923401550; 7030963217, 02164-242772	Solapur - Budharpeth Mondhe Motors +91 9423086333, 0217-2315923; 2735081	Wardha Sri Krishna Automobiles +91 9769169180 +91 7410061121
Pune - Wakad (Talegaon) Kings Auto Riders 91 9146054611	Purna road-Nanded NANDI MOTORS +91 8975943376	Ahmednagar - Opp Petrol Pump Karachiwala Automobile +91 9028537570	Solapur - Pandharpur Mondhe Motors +91 9423591471	Yavatmal Aaditya Riders Pvt Ltd +91 8055958119 9158632833
Pune - Wakhewade Brahma Motors +91 7276629900, 7888002033, 7276027722	Ratnagiri Advait Motors +91 9970551171, 8237765439, 02352-228930, 228921	Shrirampur Karachiwala Automobiles +91 9028537570, 8793935544 02422- 227570	Udgir SAIRAJ WHEELS +91 9405054417	MANIPUR
Pune - Wakad Opp. Orittel Hotel Kings Auto Riders +91 9527202020	Sangli Abhay Auto +91 7768073003; 0233-2623040	Solapur - Bale chowk, Pune Highway Chavan Motors +91 7720069988; 8805568000, 0217-2352323; 2352424	Wagholi - NR Yashraj Inn Hotel Chopada Motors LLP +91 9172202400	Imphal Sanamahhi Motors +91 8259061598, 7085970845, 0385-2449111
Pune - Wellesley Road, Sangamwadi Brahma Motors +91 7888002033; 7276307799	Sangli- Chandanwadi, Miraj Hare Madhav Motors LLP +91 9970162710		Manipur - M G Avenue Imphal ADHIKARI ENTRPRISES +91 9856148449	Tipaimukh road-Churachandpur PAUL'S MOTORCYCLES +91 9862658259

AUTHORISED DEALERS

MANIPUR	NAGALAND	NEW DELHI & NCR	NEW DELHI & NCR	NEW DELHI & NCR
Indo-burma-sugunu road, kakching Kakching Motors +91 9774274945	Dimapur Uniglobe Enterprises +91 9774057770 9089599134, 3862225903	Delhi - Arjun Nagar; Kotla Mubarak Pur Ess Aar Motors +91 9560088256	Delhi - Mangolpuri Soni Automobiles +91 9910477162; 9599004454 011-27915837; 27910525	Delhi - Saraswati Vihar North Delhi Motorcycles 91 8130495935 011-27054737
MEGHALAYA	NEW DELHI & NCR	Delhi - Kailash colony, Okhla Indust. Area South Delhi Motorcycles +91 9716145509; 9560088256, 011-41327936, 46121558	Delhi - Najafgarh Outer Delhi Motorcycles +91 9540941605 011 68888252 / 53	Delhi - Shahadra Amar Autos +91 9990092800 011-43595322
Shillong Merin's Royal Enfield +91 8258811320 9856067586 0364-2590048	Delhi - Dwarka Cruiser Motors Pvt Ltd +91 9136409595; 9599051780	Northwest Delhi- Wazirpur Industrial Area United Automobiles +91 9999805797; 7290037111	Delhi - Village Samalka Kapashera Outer Delhi Motorcycles +91 9540941601	South Ganesh Nagar, East Delhi Amar Autos +91 9810092800
MIZORAM	Delhi - Gujrawala Kay's Auto +91 7838372323 011-28877011; 28877009	Delhi - Mahipalpur Kay Tee Automobiles +91 9910884777 011-65662777	Delhi - Paratpanganj Asco Motors +91 8527321899 011-2214888	Southwest Delhi- Mayapuri Industrial Phase 2 Sunshine Automobiles +91 9167640122; 8130288284
Aizawal Lawma Enfield +91 8575517879, 8794386109, 0389-2334731	Delhi - Rani Jhansi Road Ess Aar Motors +91 9810797099 011-65461901; 23524426			
Opposite faith Hospital, Chanmari-III Alpha Riders +91 7640995613	Delhi - Near Sai Temple Ess Aar Motors +91 9990092800			

AUTHORISED DEALERS

NEW DELHI & NCR	NEW DELHI & NCR	NEW DELHI & NCR	NEW DELHI & NCR	NEW DELHI & NCR
Delhi - Tilaknagar Lamba Enterprises Pvt Ltd. +91 9250919993; 9250919994, 011-45614855; 42138246	New Delhi; Karol Bagh KINEMATICS MARKETING CO. +91 9310787108 New Delhi; Libaspur GT Karnal Road BNT Motors Pvt Ltd +91 9717391900 Lala Lajpat Rai Marg Zumrudpur-New Delhi Dee Pee Motors +91 9811477949	NCR - NIT Faridabad Sohan Auto World +91 9811535853 0129-2429352,9311551530 NCR - Ghaziabad - Nehru Nagar Rawal Automobiles Pvt Ltd +91 9350315311; 9211921227, 0120-4104659 Ghaziabad (ASP) Jai Shiv enterprises +91 9927064206 Ghaziabad (ASP) Royal Taj Agency +91 9871045697	NCR Gurgaon - Old Delhi Road Aman Automobiles +91 9811247041; 9811247048, 0124 4084648 NCR Gurgaon - Sheetala Mata road Brawn Automobiles +91 9212315090 0124 4251481 NCR Gurgaon - Sohna Road Manzil Motors Pvt. Ltd. +91 8527540101 0124 4600100 NCR-Noida - Sector 10 Shree Mahadev Agency +91 9310047588 0120-4310052/ 4324662	NCR-Noida - Sector 63 Solitaire Automotive +91 9599195030 0120-4547929 Noida-Gautam Budh Nagar Shree ji Automobiles +91 9811112256 NCR-Sahibabad Sangam Autos +91 9311051177; 9990624290, 0120-4198890 ORISSA Angul Green Treet Automotive (P) Ltd +91 9937066505 +91 7852936512 Balasore Favour Ride +91 7894775144; 90400557156
Delhi - Naraina Centrum Motorcycles LLP +91 9910168168; 9871597779	Delhi (ASP) M.G. Auto Sales +91 9810237417 011-27837439 NCR - Faridabad - Mathura Road Heighten Automotive Pvt Ltd +91 9911223811 9718990007/9312310046	Patel Nagar II, Ghaziabad Shiva Riders +91 9560192108; 8448891071		
New Delhi Company Store Saket New Delhi +91 7533006563				
New Delhi Company Store - Khan Market +91 9716520520				
New Delhi (ASP) Balaji Motors +91 9717831925 +91 8826574278				

AUTHORISED DEALERS

ORISSA Bargarh Shree Shyamji Bike Point +91 9437053233 +91 7381053244; 255	ORISSA Bhubaneswar - KIIT Road, Sishu Vihar Gugnani Automobiles +91 9776160313; 9040510010	ORISSA Madhupatna-Cuttack Anmol Motors +91 9437018811; 8338925660	ORISSA Rourkela The Agents & Distributors +91 9937007971; 9238111010; 0661-2511223	ORISSA Bhubaneswar, Laxmi Sagar Orissa Marketing Services +91 9337515332
Baripada Legend Automotive +91 9178024417; 9040078001	Bhubaneswar - NH 5 - Patrapada Trupti Autoworld +91 9861824216; 7873024206, 0674-2470148	Cuttack Shree Hanuman Automobiles +91 8342039286; 9438429957 0671-2586630; 9853265588	Sambhalpur Sreyasri Motors +91 9040015355; 9040015356	PONDICHERRY Pondy-Karuvadikuppam Rooster Automobiles + 91 7639001066 0413-2355336, 2355330
Bhadrakh Jyotshna Automobiles +91 7852940689; 7852940691	Bhawanipatana Shyamkrishna Mart pvt ltd +91 9040350293, 9777048530, 8763130236	Jajpur Road Birendra Motors +91 9078886306; 9078886302	Cuttack-Odisha Bullet Plus +91 9437037590	Mudaliarpet Rooster Automobiles +91 9791322522, 04142-227788
Berhampur Vaishnavi Automobiles +91 9937308525; 7682833574; 6802248820	Phulnakhra-Cuttack Khimji Automobiles LLP +91 9937022588; 7735286061	Jeypore Golden Motors +91 9439122306; 9437024187	ODISHA - Nayagarh RAHUL AUTOMOBILES +91 7978376478	Karaikal Rooster Automobiles +91 8489155655 , 7639001047, 04368-228800
Bhubaneswar - Buddha Nagar Royal Automobiles +91 7752017606, 7752017602, 8192256239	Station Bazar-Dhenkanal SHIVAY MOTORS +91 9437076918	Keonjhar Sai Automobile +91 9437054807 9114611733, 9437004711	Puri Odisha-VIP Road, Puri Puri Town PGS Motors +91 9437028009	PUNJAB Abohar Aman Auto Zone +91 9814767900

AUTHORISED DEALERS

PUNJAB	PUNJAB	PUNJAB	PUNJAB	PUNJAB
Amritsar Jaycee Motors Corporation +91 9780038349 +91 9780038078	Barnala Megan Autos +91 9878120088 +91 9878120033	Faridkot Baba Farid Automobiles +91 9780247048; 9872409626, 01639-251343	Gurdaspur Ajit Motors +91 9855152204 01874-501644	Jalandar - Satluj Market Navyug Motors +91 9915630535; 9878785796 0181-4627998
Amritsar Aaray Motors +91 8054053222; 9517777402	Batala Moon Autos +91 9988355955	Fazilka Aman Auto Zone +91 9988700765; 9814667900	Hamirpur Parkash Royal Automobiles 91 9418458483; 9418945283, 01972-258483	Jalandar - G.T.Road Near BSF Chowk Navyug Motors 91 9878785796; 9915630535; 7696055345, 0181-4627998
Amritsar Gee Ess Enterprises +91 9878930900	Begowal S.S.Motors +91 9814399532; 7526866633	Ferozepur Royal Hut +91 8437312364 01632-242567	Hoshiarpur Lagwal Automobiles +91 9256514321 01882-238586	Jalandar - Opp Indian Petrol Pump RAJA RAM & SONS +91 9888423456; 8437003236
Amritsar - Opp: Guru Harkrishan Public School Jaycee Motors Corporation +91 9780020654 +91 9780038078	Bhatinda-Goniana Road Ajay Autos +91 9988678145 0164-2235608; 5000376	Ferozepur - NH - 54, Amritsar Royal Hut Unit - II - SERVICE +91 7087799707	Jalandhar - GT Road Fateh Autos +91 9417231123 0181-2632880	Kapurthala Innovative Automobiles +91 9357254736 01822-233011
Amritsar - Khasra no - 361 Jaycee Motors Corporation +91 9780038018	Bhatinda - Mansa Road Krishna Automobiles +91 8725086888 9988445802, 0164-2212802	Fazilka Aman Auto Zone. +91 9814667900	Jalandhar-Kapurthala Road Fateh Motors +91 9530907183	

AUTHORISED DEALERS

PUNJAB	PUNJAB	PUNJAB	PUNJAB	PUNJAB
Khanna Kishori Automobiles +91 9872030903; 01628-503868	Mahilpur Mahilpur Motors +91 9417354423; 7508390043	Morinda Morinda Motorcycle Centre +91 8427242324 0160-2630357; 2630072	Nangal Nangal Motors +91 8283829760; 9878667432; 01887-229160	Phagwara Khalsa Automobiles +91 9463138303 01824-270081
Ludhiana - Dholewal - GT Road Sant Motors +91 8968296020 0161-5012647	Malerkotla Om Automobiles +91 9814404513; 8054944713, 01675-262113	Mukherian Lagwal Motors +91 9988048699	Nawanshahar HS Enterprises +91 9417654888; 8146091105; 01823-221194	Ropar Garcha Automobiles +91 9464752267 01881-228137
Ludhiana - Gurudev Nagar - ferozpur Road Barnala Automobiles(Jagroan) +91 9780014995 0161-2424114; 2426209	Mansa Ganpati Motors +91 9915445444 01652-236899	Muktsar Deep Autos +91 8566926850 9914367900	Pathankot Cashmir Sales Corporation +91 9417412884 0186-2220148; 2224672	Sangrur Verma Automobiles +91 9888836998 01672-223273
Ludhiana; Near Dhuri Railway Crossing AMRIK SINGH & CO. +91 9592311555	Moga Bikram Sales Corporation +91 9855914072 7009263044, 01636-227777	Nabha Partap Automobiles +91 9815001739; 9815001740, 9872605400	Patiala - Rajpura Road Sukhdev Automobiles +91 9876103017 0175-2305721	Sultanpur Lodhi Dalbir Motors +91 9814679432 9781192204 01828-223634
Ludhiana; Basti Jodhewal Ashtavakra Auto Pvt. Ltd.-Service +91 8725092400	Mohali Manmohan Motors +91 9216267888; 9988317366 0172-6527366; 6527367	Nakodar (ASP) Bhagwati Automobiles +91 9357242788 +91 9041522970	Patiala - Sirhind Road Gurukirpa Motors +91 9779222225	Tanda Sandeep Automobiles +91 9814392398 01886-502398

AUTHORISED DEALERS

PUNJAB	RAJASTHAN	RAJASTHAN	RAJASTHAN	RAJASTHAN
Taran Taran Chhabra Auto Agencies +91 9356579808	Banswara Veer Autolinks +91 9001406681 02962-254135	Bundi Ramdutt Automobiles Pvt Ltd +91 7597212390	Jaipur-Sodala, Giitanjali Towers Company Store Jaipur +91 7737009665	Jodhpur Shree Rajpurohit Automobiles +91 9001744442, 9166780687, 0291-2980473
Zirakhpur Garg Auto zone +91 8427656388	Barmer Devrath Motors Pvt. Ltd +91 8107381111; 9549657080, 02982-224381	Chittorgarh Manglam Motocorp +91 9829289699; 9414420222, 01472-297018	Jaipur - Govind Marg Rajesh Motors (Raj.) Pvt Ltd. +91 9001171222	Jodhpur Modern Motor Bikes +91 7222011196 +91 7222011197
RAJASTHAN		Churu Churu Balaji Motors Pvt Ltd +91 9649777777 01562-253777	Jaipur - Tonk Road Aditi Motors +91 9829822722 0141-2700224	Jodhpur Sushila Auto Agency +91 8619095658
Ajmer Jogbala Motors Pvt Ltd. +91 9829072298 0145-2787666	Bharatpur Khusali Motors +91 9414944972	Dausa Ashirwad motors +91 9414036326	Jaipur (ASP)-Sudershan Pura JMS & Co +91 7239902225 0141-4059277	Kota MUNDRA MOTOR COMPANY +91 7891001013, 0744-2361264
Ajmer- Vaishali Nagar Ajmer Motorcycles +91 9928075500; 7412029114	Bhilwara Soni Automobile +91 8233416700 011 27921311; 65902249	Dungarpur MANGLAM MOTORS +91 7014157496	Jhunjhunu Balaji Motors +91 7733022411 01592-231061	Kotputli Shree Motors +91 9468768300; 7023499999
Alwar R.S. Motors +91 8696900842; 9785999998, 0144-2738248	Bikaner Bikaner Bikes Pvt Ltd +91 9529269924 0151-2251345	Hanumangarh Udai Motors +91 9772780001 01552-226266		

AUTHORISED DEALERS

RAJASTHAN	RAJASTHAN	RAJASTHAN	TAMILNADU	TAMILNADU
Nagaur D.D.Autotech +91 9828943737 +91 7737237475, 01582-243006	Sriganganagar National Motors +91 9414211956 0154-2444200	Jalor Achal Gavri Motors +91 9784384848, +91 7976933204	Chennai - Ambattur Classic Motorcycles +91 9940063306 044-42180206 - 45080207	Chennai - Jafferkhanpet Sreehita Auto Zone +91 7338819603; 7338819602, 04; 05 044-65906590; 591
Pali RMD Motors +91 9829285357 +91 9983268151, 0293-2227151	Tor Ka Pura Dholpur Digvendra Motors Pvt. Ltd. - Service +91 9829189678	TAMILNADU Arani Akan Agency +91 9751059933; 9585503415, 7845330209	Chennai - Anna Nagar Southern Motors +91 9841277990 044-26264686	Chennai - Kattuppakkam Aravinduja Motors Prt. Ltd. +91 8939804335 044-45554888
Pali Road Sumerpur VRS Motors LLP +91 8107781952	Udaipur Voyage Motors +91 7340069355; 7340684255, 0294-2467465	Arumbakkam - Chennai Rudraa Motors +91 7550226015; 7550226016; 7550221163	Chennai-Behind LIC KSR ENTERPRISES +91 9444191313	Chennai - Kelambakkam Vardhan Motors +91 9092604446 +91 9092604447
Sawai Madhopur Vachi Motors Private Limited +91 8769999520	Udaipur The KPM motors LLP +91 9116124507; 9414385732	Brookefields Mall- Coimbatore Sheriff Motors – Brookefields +91 9940002305	Chennai - Chrompet The Legend Motors +91 7299042018, 9841699117, 044-49595867; 22410272	Chennai-OMR, Perungudi Royal Enfield Company store +91 8939958655 044 - 24542829; 65716303
Sikar Apoorva Motors +91 9314237183 01572-245830	Jhalrapatan (Jhalawar) Smart Choice automotive +91 9772167555; 9116124507, 07432-241347	Chengalpattu-GST Road Shiv Sholai motors +91 9500008699 +91 9786177477	Chennai - Greams Road Sri Velavan Motors +91 8754553411; 8754553404 044-42076898	Chennai - Pallikaranai Sri Venkateswara Bike Zone +91 8681863330 044-65655222

AUTHORISED DEALERS

TAMILNADU	TAMILNADU	TAMILNADU	TAMILNADU	TAMILNADU
Chennai - Purasaiwalkam I Speed Motors +91 9094633712 9094633708, 044 45588047	Coimbatore - Hope College, Peelamedu Royal Enfield Company Store +91 9655999844 0422-6067006; 6067007	Dharmapuri S.M.Motors +91 7373778259, 9994852482; 9894142977, 04342-288123	Hosur Sri Saravana Motors +91 9543813032; 8220013432 04344-244030/ 244031	Karur Murugan Motors +91 9500955950; 9543255950
Chennai - Red Hills AKG Motors +91 9597082571 044-26322063	Coimbatore - Sai Baba colony Sheriff Motors +91 9597310101 9790510101, 0422-4210101	Dindigul Rajendra Automobiles +91 965933433, 8508678333 9486963396, 0451-2431850	Hosur (ASP) - Seetharam Nager Sri Manjunatha Bullet Garage +91 9894955499; 9940909908, 0434-4314114	Kovilpatti - Ettypuram Road Charles Motors - KVP +91 9944723062
Chennai - Thirumullaivoyal Dino Motorcycles +91 9360808030; 044-35355051	Coimbatore - Trichy Road, Kothari Layout BullMenn Motors +91 9514555510; 7092300000, 7092900000	Erode Senthil Murugan Auto Agencies +91 8220048567 +91 9790030003	Kanchipuram Jet Blaze Motors +91 9629032223; 9894538176, 8883788848	Krishnagiri Sree Maruthi Motor & Auto Service +91 9159566613 , 9003020017; 9443237512 0434-3232512
Chinnamoopanpatti Village-Virudhunagar Siva Motors +91 9626566688	Cuddalore Rooster Automobiles +91 7639001046	Erode-Thindal Senthil Murugan Auto Agencies +91 8220048567	Kallakurichi Garuda Automobiles +91 8489144944	Kumbakonam A.V. Motors +91 8903707782; 9944500127 0435-2415286
Coimbatore SHERIFF MOTORCYCLES +91 7397791001	Cumbum Coral Moto Hub CBM +91 9500739686	Gobichettipalayam EAGLE MOTOR +91 9443313189	Karaikkudi Neha Motors +91 7373097717, 7373097715	

AUTHORISED DEALERS

TAMILNADU	TAMILNADU	TAMILNADU	TAMILNADU	TAMILNADU
Madurai - Kazhavasal, Theni main road Classic Motors +91 9629023344 0452-2667875	Mettupalayam M R Motors +91 8903881798	Palani A.R. Motors +91 6381807292	Perambalur V.P Motors +91 9786656588 7373799687; 7373799686	Salem - Four Roads Chamundi Enfield +91 8098611999; 8098559999, 0427-2414100
Madurai - KK Nagar Madras Motors +91 9976755111 0452-2585686	Nagercoil Chandra Motors +91 8973886699 04652-236477	Pedhikuppam Village Gummipoondi AKG Motors +91 9087886651	Periyar Colony-Tirupur RIDERZ +91 8098501777	Salem-Seelanaickenpatti MSV Motor +91 9600200300; 9566669990
Madurai Main Road, Usilampatti Classic Motors +91 9524099444	Namakkal Royal Annanmar +91 8883115777; 8883114777, 04286-277557; 8883150077	Portblair-Dollygunj Nikhil Motors +91 9531890000	Pollachi Bharat Motors +91 9715222600 +91 9843345461	Sathy Main Road- Erode ERODE MOTORS +91 9443778855
Madurai - Simmakal, Workshop Road G.G. Motors +91 8012688444 9994979758, 0452-2342007	Neyveli-Gandhi nagar; Near Neyveli Arch Abi Motors +91 9384104041	Palavakkam Suriya Motors LLP +91 9790799699	Pudhukottai Sri Maruti Motors +91 9003020017	Sivakasi - Viruthunagar Leo Motors +91 9994847327
Marthandam Royal Phoenix Motors Pvt. Ltd. +91 9443339130	Ooty - Opp Jayam Complex M.R.Motors +91 9500977327	Palayamkottai DG Motors +91 9988776655	Ramanathapuram Murugan motors +91 9488107000	Thanjavur JAF Associates +91 7867019836; 7867019838
		Pechavadi-Nagapattinam A.V. Motors +91 7094450523	Salem-Attur K.R.K Bikes +91 9790017570	

AUTHORISED DEALERS

TAMILNADU	TAMILNADU	TAMILNADU	TAMILNADU	TELANGANA
Thiruvallur Gap Motors +91 8939983660 8939983662, 9087887123	Thoothkudi Charles Motors +91 9944723062; 9894555702, 0461-2321636	Tiruppur-Dharapuram SENTHUR MOTORS +91 9442121345	Viruthampet, Vellore Sri Kalikambal Autos +91 9655011198	Hyderabad-Bahadurpura VVC Automobiles +91 9642649999
Theni Coral Moto Hub +91 9500739686 9698933000	Tiruchengode Royal Annanmar +91 9500023907; 8883178777	Thiruvarur Shri Balaji Motors +91 9965293949; 7397768020	Villupuram Rooster Automobiles +91 7639001008, 04146-222280	Hyderabad-Bowenpally, Suchitra SVR Motors and Engineering +91 8885023360; 9133322923, 040-40116336
Thenkasi- Railway road RK Motors +91 9783838823	Tirunelveli DG Motors +91 8973846699; 9486729010, 0462-2970031	Trichy - Annamalai Nagar Karur road Oxina Motors +91 9655900555 7402718502; 7402718512	TELANGANA	Hyderabad-Erragada Royal Enfield Company Store +91 7093190003/ 7416783025
Thiruvannamalai AKAN Agency +91 9751509147; 9585503415, 04175-233377	Tirupattur-Vaniyambadi Main Road AVS Agencies +91 9751665553	Trichy-Contonment M/s.Grande Motors +91 9600999127	Adilabad Ashwik Motors +91 8732222770; 8297388776	Hyderabad-Himmayat Nagar Jayasree Automotives +91 9010369555, 040-65169666
Thiruvottiyur-New Washermentpet DCS MOTORS PRIVATE LIMITED +91 9944929897	Tirupur Bikerz +91 7502387000 +91 9842187000	Udumalpet Bharat Motors +91 9715222600	HYDERABAD & SECUNDARABAD Hyderabad Cyber Automobiles Pvt Ltd +91 9963223271	Hyderabad-Rangareddy Jayasree Automotives +91 7093612612
		Vellore-Arni Road AMBIGA MOTORS +91 9894811111	Hyderabad- Banjara Hills VVC Automobiles +91 7842883883, 9988776655	

AUTHORISED DEALERS

TELANGANA Hyderabad-PJR Nagar, Gachibowli road Go Green Motors India Pvt. Ltd +91 9059929929, 040-64626265; 64646303	TELANGANA Hyderabad-Karmanghat Taurus Motors KMG +91 9100828787	TELANGANA Hyderabad-Sanath nagar Company Showroom +91 8686099601	TELANGANA Malakpet Hyderabad Dark Matter Motorcycles +91 9908000533; 8886676041, 9014201359	TELANGANA Secundarabad-Opp-KIMS Hospital, Ranigunj Kayjee Engineers 040 - 64533839
Ghatkesar-Shiva Reddy Guda Main road CK Riders +91 8019090190; 9704511755	Hyderabad-Ramachandrapuram, BHEL Go Green Motors India Pvt. Ltd +91 8712126622 040-69996644; 69996622	Hyderabad-Zafferguda, Mehidipatnam Venkataramana Automobiles Pvt Ltd +91 7660008132; 9100087519, 040-23514551	Siddipet-Hyderabad Road Anil Motors +91 9555899999	Karimnagar - Bye pass Road Quality Motors +91 9966173000 0878-6509993
Hyderabad-PJR Nagar, Gachibowli road Go Green Motors India Pvt. Ltd 040-64646303 040-64626265	Hyderabad-Medchal Taluka Keesara Mandal Orange International +91 9989899098	Kukatpally Hyderabad Headway Motors +91 8978953520, +91 9100199909	Secundarabad-Begumpet Kayjee Engineers +91 9246113133 040-27907444	Karimnagar-CVNR Road Quality Motors +91 9030775252
Hyderabad-Prasanth Nagar,vanasthalipuram Taurus Motors +91 8125828787 040-29804755	Hyderabad-Saraswathi Nagar, Uppal Royal Engineers +91 9885051755 040-64241755	Madhinaguda Village, Ranga Reddy Headway Motors +91 9963145145	Secundrabad-Neredmet Orange International +91 8121091210 040-64449494; 3434	Khammam Royal Automotives +91 9963886789 8297516789, 8297536789
		Mancherial Road, Divya Nagar Ashwik Motors - Nirmal +91 8790378922	Secundrabad-Trimulgherry SVR Motors +91 9133322926	Khammam- Sathupally Hemanth Automotive +91 9032033203

AUTHORISED DEALERS

TELANGANA	TELANGANA	TRIPURA	UTTRANCHAL	UTTRANCHAL
Kothagudam Royal Motors +91 8297616789 8297516789, 8297626789	Nalgonda Vijayalakshmi Automotives +91 8885966627 8885966687	Agartala XED Motorcycles +91 8415951975 8732005642, 0381-2341098	Banda - Tindwari Road Sohum Riders +91 9919993062	Etah -GT Road, Asroli, K.S.Royals +91 9412177432
Mahabub Nagar Harshithh Automotives +91 7660022336; 7660022334	Nizamabad KY Motors +91 8885198222 08462-236882	Agartala, West Tripura Opp:TATA Naladri Motors PNR Automobiles Pvt. Ltd +91 8794333686	Ballia- Opp- Nagaji School Parmarth Automobiles +91 7800378233, 05498- 260999	Gorakhpur- Mughal pur, Chargawa MAK Bikes LLP +91 9793909000; 7081000899, 5512505500
Mahabubnagar road, Uyyalawada Nagarkurnool Harshithh Automotives- NGKL +91 9440295767	Suryapet Vijayalakshmi automotives +91 8886677696; 8885966673	UTTRANCHAL	Bhadohi-Old Haddi mill Bhadohi Wheels +91 8934022222	Hathras- Agra Road, Hathras Manglam Royal +91 9650658883
Mancherial J V Aryan Motors +91 8179356458 +91 8297388775	Warangal SV Motors +91 8702433888; 9395144955	Almora +91 9719828826	Dehradun - Jakhan, Sai Tower Allied Auto Agency +91 9690777771	Indira Nagar, Rath Road, Orai - Jalaun Singh Royal +91 9415032417, 9454420655
Miryalguda Sri Lakshmi Pavan Automotives +91 9666660606	Warrangal-Hanamkonda Quality Automobiles +91 9030775252 +91 9030775164	Ambedkarnagar, Faizabad Road,Melahiya Bagh, Akbarpur Saurabh Automobiles +91 9838126556, 05271-246725	Dhanipur Lucknow Road, Sitapur Raj Automobile +91 9151333337	Kannauj - Akbarpur - Sarayghah Sampuranta Automobiles +91 9956284957

AUTHORISED DEALERS

UTTRANCHAL Lucknow - (Hardoi road) Lucknow Diesels & Electricals +91 9044290442	UTTRANCHAL Sidharth Nagar-Bansi road Shiva Motors +91 9628222122	UTTARKHAND Dehradun - 6-B, Niranjanpur, Near Mandi Chowk, Dehradun Allied Auto Agencies +91 7900888999 0135-2623487	UTTARKHAND Kashipur - Near city stadium, Ramnagar road Batra Enterprises +91 9837336026 05947-277207	UTTARKHAND Roorkee - Haridwar Road, Near Malkapur Chungi-247667 Goswami Automobiles +91 9897238608 01332-277477
UTTRANCHAL Krishna Vihar colony, Rae barely road, Lucknow M/s Shreya Auto World +91 9415013828; 8400400850	UTTARKHAND Shahjahanpur- Bareilly R. K Autozone +91 7703009919; 7703009918, 7703009917	UTTARKHAND Dehradun-Sant Vinoba Marg ANAMIKA ENTERPRISES +91 9897615836	UTTARKHAND Khatima Chaudhary Automobiles +91 8802927200; 8872021013, 01346-250555	UTTARKHAND Rudrapur - Brar Nagar, Rampur Road Brar Motors +91 9219445699 05944-2473127
UTTARKHAND Almora Kumaon Motors +91 9719828826	UTTARKHAND Haldwani, Nanital Suri Sales (P) Limited +91 7351007972 05946-210768	UTTARKHAND Pithoragarh (ASP) Sai Automobiles +91 9412981042 05964-225786	UTTAR PRADESH Agra - 4/64, Opp.DIG Residence Baluganj Shambhavi Automotive Engineers +91 8057400022, 8057400055, 0562-2260444	
UTTARKHAND Mirzapur; Nr. Binani College Vindhya Auto Sales +91 9565799799, 05442-220728	UTTARKHAND Chaudhary Niwas; Pauri Garhwal- Srinagar Chaudhary Automobiles +91 9758400555	UTTARKHAND Haridwar - Jwalapur, Railway Station Road 249407 Prem Auto Enterprises +91 9927994477 01334-250242; 253242		
UTTARKHAND Near Banjari Moad, Lucknow Road Rudra Motors +91 9695497774	UTTARKHAND Dehradun-Karanpur Road Ahuja Enterprises +91 9927532535 0135-2659082			

AUTHORISED DEALERS

UTTAR PRADESH	UTTAR PRADESH	UTTAR PRADESH	UTTAR PRADESH	UTTAR PRADESH
AGRA-Guru Ka Tal-NH 2 Agra Royals +91 7055312114 0562-6888846	Allahabad - Bai Ka Bagh Vrindavan Automotive +91 7860861786 0532-2417021	Badaun - Near FCI godown Omkar Motors +91 9412427289 9520330305	Basti - Didoha pachpediya road. New India Merchant +91 9532211786 554 2281483	Deoria - Barhaj Road Supreem Motors +91 9415312814 05568-229624
Agra - Kheragarh Agra Royals Unit II +91 7456002600	Allahabad-Kamia Nehru Hospital Jay Pee Motors +91 9161728300, 0532-6061002;1003	Barabanki - Nawabganj 225001 G.R & Company +91 7233002407, 05248220223	Chandauli, Uttar Pradesh Shri Sai Automobiles +91 7571855565; 7311178055	Etawah - Ram Leela Road V P Motors +91 9568013106; 9568013109, 9568013105
Agra - Trans Yamuna Colony Mangal Motors Private Limited +91 9105900111	Amroha-Delhi Moradabad Road Near KFC ADVIKA AUTOMOBILES +91 8938930882	Bareilly - Nainital road Suri Sales (P) Limited +91 9359108047 0581-2543334	Bijnor - Landmark Hyundai showroom Chaudhary Motors +91 8958994499 01342-264455	Faizabad - Wazeerganj Chawla Riders +91 9628730002 0527-8265077/78
Aligarh - Nr Banna Devi Police station, GT Road, Exhibition Ground Maindola Royal Enfield +91 9319144044, 9319155055, 0571-3292464	Azamgarh - MAu road, Sidhari Amit Motors +91 9415103787	Bariely AJS RIDERS PVT LTD +91 9927880000; 9761200010	Bulandshahar - State Bank Colony Santhosh Enterprises +91 9219445515 05732-231326	Farrukhabad - Ghatiyaghat Road Ankur Auto Agencies +91 9415124921 +91 9792952111
Aligarh-Ramghat Road Kodia Auto Sales +91 7055520172	Balrampur Titu Automobiles +91 9918101234			Fatehpur - Near DM Awas K S Auto Sales +91 9616519248 05180-221223

AUTHORISED DEALERS

UTTAR PRADESH Firozabad - NH-2, Nagla Bhau Emerald Automobiles +91 9219439555 +91 9219439444	UTTAR PRADESH Gonda Style N Passion +91 9919713001 Gorakhpur - Taramandal Shiv Motors (A Unit of Pardeshi Zigwheels Pvt. Ltd.) +91 7706900011 0551-2230014 Hapur- Tyagi Market, NH-24, Opp. Saraswati Enclave Anmol Automobiles +91 7217480005; 7217480001	UTTAR PRADESH Jaunpur - Nr. Yamaha Showroom Aditya Motors +91 9196128730; 9839216882 0545-2264047 Jhansi - Near SBI Triveni Enterprises +91 9936997777, 7607779147, 0510-2481007; 2380007 MAINPURI-Bhawat Chauraha Railway Station Road GANESH MOTORS +91 8909523231	UTTAR PRADESH Kanpur-Rambagh post office Sareen Motors LLP +91 7705905143 Kanpur - W-1/52, Saket Nagar S.S Automobiles +91 7705006411, 7705006401 Khalilabad Kabir Automobiles +91 9717522230 Lakhimpur Kheri Shree Vinayak Motors +91 7071187827 0587 2277734	UTTAR PRADESH Lucknow - 5A, Adarsh nagar Shreya Auto World Pvt. Ltd. +91 8400400842; 850 0522-4037677; 4041033 Lucknow - A 1/1 Sec F Jankipuram Lucknow 226021 Royal Motor works +91 9839211000; 7607777386, 522 4078111 Lucknow Company Store Lucknow +91 8126777150 Lucknow-Near Syndicate Bank Sardhana AYAN AUTO LLP +91 9910031141 Maharajganj - Chauparia Pharenda road RK Motors +91 7571006171
UTTAR PRADESH Ghaziabad-Loni ROYAL TAJ AGENCY +91 9871045697 Ghaziipur - Bansi Bazar Shri Sai Chandra Automobiles +91 7571006171 Ghaziabad-NEAR MOHAN NAGAR FLOYER Sangam Autos +91 9311051177	UTTAR PRADESH Hardoi Raj Royals +91 7081000522; 9919897999	UTTAR PRADESH Kanpur-Khalasa Line Sareen Motors LLP +91 77705905138; 7705905143, 8303220224	UTTAR PRADESH Lucknow (ASP), Near Goel Hospital Amafh Bullet Centre +91 9415018786 7080811662, 0522-4074200	

AUTHORISED DEALERS

UTTAR PRADESH Mathura - NH-2, Nr. Jaiguru Dev Temple Aryaman Enterprises +91 8392916222; 8392916221	UTTAR PRADESH Moradabad - Near pak vada Akanksha Autozone Pvt Ltd. +91 7247800081 0591-6055999	UTTAR PRADESH Noida-Gautam Budh Nagar SHREE MAHADEV AGENCY +91 9310047588	UTTAR PRADESH Pratapgarh - Near Angels school Shaurya Enterprises +91 9554433888;	UTTAR PRADESH Shamli-Panipal Road AJ Automobiles +91 8467077437
MAU - Batwal, Nr Eicher TRactors Chandra Motors +91 7310266900, 0547-2860555	Muzaffar Nagar Harivansh Auto Agency +91 9219440446; 8979298645 0131-2646477	Noida-Gautam Budh Nagar-Opp Fortune Hyundai Shree ji Automobiles +91 9310047588	Raebareli - Plot no.1414, Civil Line Sushma Motors +91 8953005001	Sultanpur - Kasba KNIT Asia Royal Motors +91 8115054400 05362-227777
Meerut - 8, ShriKrishna Tower Moto Riders +91 8476900096, 9536900541, 0121-4000511	Nazibabads - kotwali road,near railway crossing Agarwal Tractor & Parts +91 9927030546; 9837072868, 01341-220252	Padrauna - PLOT no.2353, Kasya road, Chavni Cantech Automobiles +91 9838719444; 7705803777; 05564245959	Rampur Hospital - Nainital Road Akanksha Autozone P. Ltd +91 7247800081	Unnao - 3-98, AWAS VIKAS COLONY Raj Auto World +91 7080903700, 7080903720, 0515-2831098
Meerut - West rithani, 28, Meerut-Delhi Road Nutech motors +91 7088714714 0121-440111	Near Signet Automobiles- Baghpat Pitambra Automobiles +91 9412887130	Patel Nagar II ,Ghaziabad Shiva Riders +91 8448891071	Saharanpur - Hanuman Road Sachdeva Enterprises +91 8445577933 0132-2680680	Varanasi - Chandpur Industrial Area Khurana Automobiles +91 9956462863 0542-2207532; 2207618
		Pilibhit Shankhdhar Automobiles +91 7351667269; 7535877888	Sector-63, Noida Solitaire Automotive +91 9599155030	Varanasi-Maqbool Alam road, Nr DIG colony One Place Automobiles Pvt. Ltd. +91 9781921323, 0542-2508385

AUTHORISED DEALERS

UTTAR PRADESH	WEST BENGAL	WEST BENGAL	WEST BENGAL	WEST BENGAL
Varanasi- MAUZA SHIVDASPUR Varushka Automobiles +91 7055312114; 7572008103	Barasat-24 Parganas The Country Motors +91 9230488895; 9051506523, 033-654 04510	Durgapur R.H. Automobiles Pvt.Ltd. +91 9748402629, 8336935892	Kolkata - Chowrangee chowk Austin Distributors Pvt. Ltd +91 8420046876 033-65552077; 40721010; 60505574	Krishna Nagar Royal Automobile +91 8629961089
Varanasi-Shakti Nagar Highway Vishwanath Enterprises +91 7080109007	Baruipur-24 Parganas Austin Distributors Pvt. Ltd 033-65556611	Habra - West Bengal The Country Motors +91 9051506523	Kolkata - Nowa para Kolkata Bike Zone 91 9674029373 033-40082380	Malda Speed Wheels +91 9735586333, 7872971814
WEST BENGAL	Berhampore Maxwheel Motors +91 9233330208; 9233330216, 03482-224844	Howrah Apollon Motors LLP +91 9903800400; 9903200400	Kolkata-Sarat Bose road Shah Distributors (Auto Division) +91 9830477788 033-22814242	Midnapore Sri Sai Auto mart +91 9434043691 7047678599, 03222-275999
Asansol SG Automobiles +91 8170030004	Burdwan Sri Ram Automobiles + 91 9800365544, 9002450705, 9732050705	Kharagpur Jain Motors +91 9476481717 9434692778, 9800226657	Kolkata - Shakespeare Sarani East India Agro Indus. Pvt. Ltd +91 9874977006 033-22824400; 22823300; 22903370	Purulia High way- Purulia Devi Motors +91 9060827198; 7022543773; 6295900922
Asansol SG Automobiles- Unit I +91 9733212991	Darjeeling-Burdwan Road Legendry Motors Pvt. Ltd. +91 9775430000	Kolkata - Anandapur Royal Enfield Zonal Office 033-40461000 033-40060206 / 0209		Purba Medinipur Shivani Automobiles +91 7477787028
Bankura R D Automobiles +91 9083282541	Dankuni-Hooghly Universal Traders +91 9883069797, 9831018699			

AUTHORISED DEALERS

WEST BENGAL	WEST BENGAL			
Purba Medinipur-Ratnali Suhana Global Private Limited +91 9732131302	Titagarh Bishnu Oil Company +919874839911; 9051365511 033-25833353			
Raiganj Kalyani Solvex Pvt. Ltd. +91 9083292077; 9475224885, 03523-253016				
Siliguri - Matigara Riders Corner +91 9083260131; 7319042570				
Siliguri - 2nd Mile Sevoke Road Siliguri Distributors +91 9775633225; 8906949604, 0353-2778873; 2547457				
Suri- Birbhum Birbhum Riders +91 7477770008				

PARTS STOCKIST DISTRIBUTOR

Andhra Pradesh Vijayawada Cyber Automobiles Pvt. Ltd +91 9959615806	Gopalganj Shri Harishankar Motors +91 9771880938 06156-223956	Margoa Saini Motors +91 8308808290 0832-2740343; 2740345	JAMMU & KASHMIR Jammu Yahoo Technocra +91 9419191241	Bangalore Fixwheel Motors +91 9845949127
Assam Guwahati Chirag Enfield +91 8136051810 0361 2670293	Patna Moto Spares Pvt.Ltd +91 9097577727	GUJARAT Ahmedabad Shreeji Auto Traders +91 9173170931; 9724722282	JHARKHAND Hazaribagh Riders Point +91 9234343422	Kolar Jagadamba Automobiles +91 9972522111 +91 9066983741
Guwahati Pawan Automobiles +91 9864045473	CHANDIGARH Chandigarh Manchanda Autos +91 9915047010; 9988994000 0172-2630263	JamNagar New Chandra Motor Cycle House +91 9824211699	Jamshedpur Royal Auto Syndicate 72502-22283	KERALA Aluva Marikar Motors Ltd +81 9894744880
Jorhat Achharsingh Royal +91 9707522666	CHATTISGARH Raipur Nagorao Auto Engg Works Pvt. Ltd. +91 9165878692	HARYANA Ambala Royal Motors 0171-2545795	Ranchi Sri Nivas Automobiles +91 7763801824	Calicut Luha Automotives +91 7025106888 0495-2333533
BIHAR Biharshariff PNN Automobile +91 9135620008	GOA Mapusa Shauna Auto Agencies +91 8326520712	Bhiwani Sheoran Automobiles +91 7056732216 01664-252216	Zittau Arjun Automobiles +91 7282820788 +91 8935849216	Ernakulam JR & Sons +91 9447063679
Chapra Supriyam Automobiles +91 9128739999 06152-242999			KARNATAKA Bangalore Cyber Automobiles Pvt. Ltd +91 9448473078	Kochi Bhavani Auto Distributors +91 8086078173

PARTS STOCKIST DISTRIBUTOR

Trivandrum Subha Auto Wares +91 9446562640	Nagpur Siddarth Spares +91 9373195554	PUNJAB Amritsar Gee Ess Enterprise +91 9878930900	Erode Senthilmurugan Auto Parts +91 9894756567	Lucknow-Transport Nagar Moped House Pvt.Ltd +91 9696202669; 8795444497
MADHYA PRADESH Indore Royal Ventures +91 9589541950	Pune Planet Spares +91 9371005335	Ludhiana Amrik Singh & Co. +91 9915069033	Madurai Senthilmurugan Auto Parts +91 9500786567	Lucknow Varma Auto Sales +91 9335207393
Jabalpur Bhawani Automobiles 094243-05880	Pune Shree Spares +91 9822377709	RAJASTHAN Jaipur-Indra Bazar Shubham Agencies +91 9680465973	TELANGANA Hyderabad Cyber Automobiles Pvt. Ltd +91 7702143186	UTTARAKHAND Dehradun Anamika Enterprises +91 9897615836
MAHARASHTRA Aurangabad Vinod Agency +91 9823336611	New Delhi Kinematics Mktg (P) Ltd. +91 9654787802 011-41545025	Jaipur-Transport Nagar Shubham Agencies +91 9414067766	UTTAR PRADESH Ghaziabad Indian Automobiles +91 9999916346; 9899288337	WEST BENGAL Kolkata Auto Marketing Agencies +91 9830325490 033-22360642; 22360643
Mumbai Rajkamal Auto & Scooter Spares +91 9833985931	ORRISA Bhubaneshwar Orissa Marketing Services +91 9437033935	TAMILNADU Chennai Cyber Auto Parts +91 7358768669	Kanpur Sareen Motors +91 9389629505	Siliguri Goyal Royal Spares +91 9434063334
Mumbai Ram Motor Cycle Co. +91 9920748891 022-27700394	Cuttack Bullet Plus +91 9437037590	Chennai Popular Motors Cycle Company +91 9698444568 044-43435365; 43435364	Lucknow-Kaiserbagh Moped House Pvt.Ltd +91 7408555502 0522-4108704	

NOTES



ROYAL ENFIELD

Part No. RAM00098/A

ROYALENFIELD.COM